

ULTIMATE REVERSE OSMOSIS SYSTEM

INSTALLATION INSTRUCTION & OWNER'S MANUAL Ver 3.2



APEC WATER



FREE DRINKING WATER.COM

All Rights Reserved © APEC Water Systems

Please keep this Owner's Manual for future reference.

It contains useful information on how to maintain and care for your
APEC Reverse Osmosis water filter system.

TABLE OF CONTENT

1.	Installation:	
	Preparation	page 1
	Filter housings assembly	page 5
	Feed water connection	page 6
	Drain saddle connection	page 10
	Faucet mounting	page 12
	Connecting the whole system	page 13
2.	Maintenance:	
	Filter change schedule & instructions	page 18
3.	Owner's Manual - RO Basics:	
	System flow diagram	page 23
	Input water pressure: most important factor	page 24
	TDS meter: testing your water quality	page 24
	Tank volume & delivery pressure	page 25
	Misc. topics	page 26
4.	Trouble-shoot Guide:	
	RO Head diagram	page 28
	Humming noise	page 29
	No water at dispensing faucet	page 29
	System slow shut-off	page 31
	TDS level higher than normal	page 33
	Filter housing is leaking	page 34
	Tank ball valve is leaking	page 35
	Pure water still taste like Tap water	page 35
	Air bubble in cup or bottle when filling	page 35
5.	Other Information:	
	AirGap Faucet Installation	page 36
6.	Warranty	page 38

***Thank you for choosing APEC reverse osmosis systems.
You now own the finest water filter in America.***

Please read and become familiar with instructions and parts needed before proceeding with the installation.

(This manual is constructed for standard APEC Ultimate RO System. For RO-PH90, RO-PERM and RO-PUMP system installation, please refer to the included addendum.)

BEFORE INSTALLATION:

Inspect the system:

Please take the system and all the components out of the box. Inspect the system and all the connection fittings carefully, make sure nothing is damaged during shipping. If any part is cracked or broken, please do not proceed with the installation and contact APEC or your distributor for an exchange or diagnosis.

Recommended tools list:

- Variable speed drill
- Drill bit: **1/4"** (for the waste line), **1/8"** (as pilot, not mandatory), and **1/2"** (for standard faucet hole, air-gap faucet requires 1&1/4" hole)
- 5/8", 9/16" open-end wrench, or adjustable wrench, pliers
- Phillips screwdriver
- Utility knife, or scissors
- Teflon tape

Operating Parameter

- Operating pressure: 85psi maximum
- Feed water temperature: 40 – 100 degree F (4-37 degree C)
- **Do not** connect this unit to **hot** water source
- Install the RO in a sheltered environment, avoid exposure to hot and cold weather or under direct sun light.

General Installation/Operation/Maintenance Requirements

- Installation needs to comply with state and local laws and regulations.
- System must be installed indoor away from possible environmental damage
- Do not use with water that is microbiologically unsafe or of unknown quality without adequate disinfection before or after system. Systems certified for cyst reduction may be used on disinfected water that may contain filterable cysts.
- This reverse osmosis system contains a replaceable treatment component critical for effective reduction of total dissolved solids. The product water shall be tested periodically to verify that system is performing satisfactorily.

Copyright:

This manual is copyrighted by APEC Inc. Under the copyright laws, this manual may not be reproduced in any form, in whole or part, without the prior written consent of APEC Inc. Manual print ver. 3.2, 2015 Jul.

Components included with the RO system:

Make sure you have all these parts before starting installation.



1 RO system head with pre installed membrane



3 Pre-filters in 3 Housings



1 Storage tank

Installation kit includes:



1 Faucet with washers and nuts



1 Feed water adaptor 3/8" - 1/2" with needle valve kit



1 Drain saddle for waste water



3 Color tubing 1/4"



1 Tank's Ball Valve



2 Wrenches for opening filter and Membrane housing



1 Faucet Adapter

Component Itemization:



- 1) Sediment pre-filter and housing (1st-stage filter)
- 2) Carbon block pre-filter and housing (2nd-stage filter)
- 3) Carbon block pre-filter and housing (3rd-stage filter)
- 4) Membrane and housing (4th-stage filter)
- 5) In-line carbon filter (5th-stage filter)
- 6) Storage tank
- 7) Tank ball valve
- 8) ASO – Automatic Shut Off valve
- 9) Check valve (Internal check valve encased in plastic fitting)
- 10) T-fitting
- 11) Feed water inlet
- 12) Product (filtered) water outlet
- 13) Bracket

Fitting Types: There are 2 types of fittings provided for connecting the system

1. **Quick-Connect (QC) fitting:** (no insert, sleeve, or nut) Most of the fittings on the RO unit are this type.

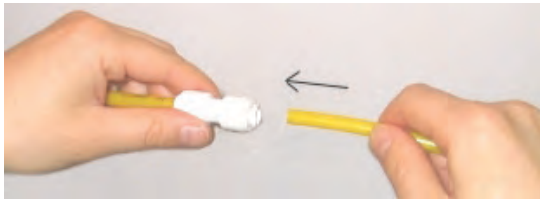

Fig. 1

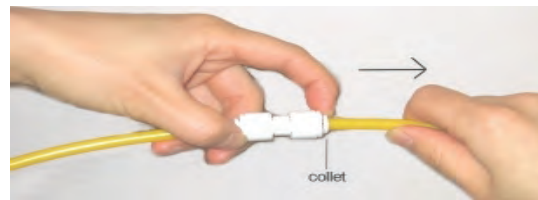

Fig. 1A

How to Connect: - See **Fig.1**. Push the tubing into the Quick-Connect fitting, then gently pull back on the tubing to make sure connection was secure.

- No inserts, sleeve, or nuts are needed to secure the connection.
- No Teflon tape!

To Disconnect: - See **Fig.1A**. Push in and hold down on the collet ring square against the fitting. With the collet held in this position the tube can be removed.

2. **Metal compression nut fitting:** (comes with 1 insert, 1 sleeve, 1 nut) Only feed water adapter-needle valve is this type.

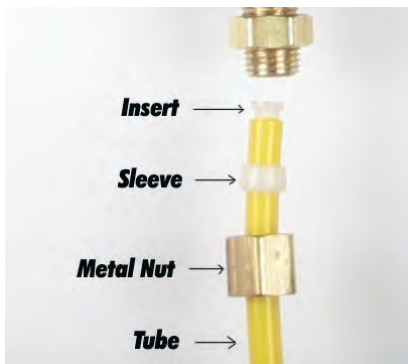

Fig.1B

Important! Use plastic sleeve and inserts on the plastic tubing we provide. Do Not use metal sleeve or insert on plastic tubing or the connection will leak!

How to connect: - See **Fig.1B**. Slide the compression nut onto the tubing.
- Slide the **plastic sleeve** onto the tubing.
- Insert the **"insert"** into the tubing.
- Insert the tubing into the opening of the fitting.
- Slide the brass nut up, then tighten nut with a wrench. No Teflon tape!
(An extra metal sleeve is provided in case you need to connect your own metal tubing. Use Teflon tape if connecting metal tubing.)

THERE ARE TWO PARTS TO INSTALLING THE RO SYSTEM:

- Part I. Assemble the filters and housings onto the main system
- Part II. Installing the system

Note: The RO Membrane Element has already been pre installed.

PART I. ASSEMBLE THE FILTERS AND HOUSINGS ONTO THE MAIN SYSTEM

Remove plastic/paper wrappings on the 3 filters, put them into the 3 housings, and assemble the housings onto the main system as follow:

1. **See Fig. 2** Stand the 3 housings upright. Make sure each housing has a rubber O-ring in its groove.
Put the APEC Sediment filter (1-SED10) into the "1st stage" housing on the right.
Put the APEC Carbon filter (23-CAB10) into the "2nd stage" housing in the middle.
Put the APEC Carbon filter (23-CAB10) into the "3rd stage" housing on the left.
2. **See Fig. 3** Starting from the 3rd stage housing on the left, hand twist the housing onto the main system turning counterclockwise, one by one, for all 3 housings.
3. **See Fig. 4** Use the wrench provided to completely tighten the housing starting from 1st-stage. Repeat this step for the 2nd stage housing in the middle, and for the 3rd stage housing on right.

Note: For some people it is easier to use the wrench with the system laid down (face up).

4. **See Pg. 3** Remove 3 end plugs (white color) from Point 10,11,12



Fig. 2

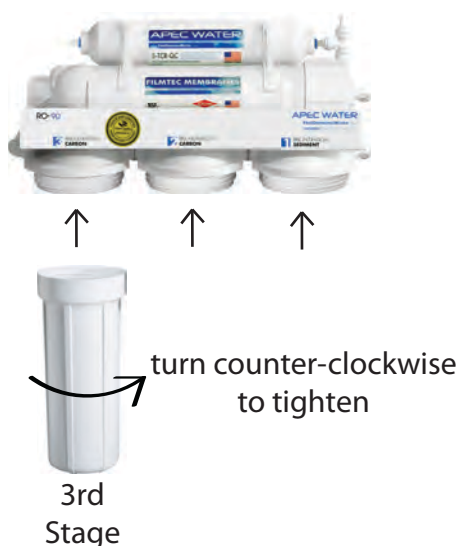

Fig. 3

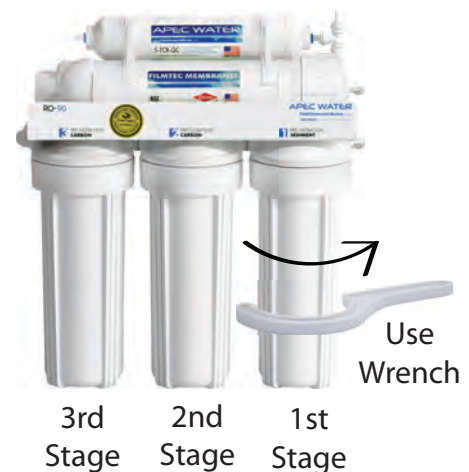

Fig. 4

PART II. INSTALLING THE SYSTEM

Space: Make sure there is sufficient space under the counter for installation (an area of about **17”L x 6”W x 18”H** for the system, **11”D x 18”H** for tank).

The RO system is best installed under the kitchen sink. But if that is not feasible you can install the system anywhere where there is a cold water supply with sufficient water pressure for the chosen RO model, and an outlet to drain off the waste water from the system.

Mounting: No need to mount the RO system on the wall. The RO system can stand in the sink cabinet without mounting, this makes future filter change easy and convenient. If you prefer to mount the system to the wall, please make sure it can be taken down easily for filter replacement.

Feed Water: RO systems are designed to treat both hard and soft water and can handle incoming TDS levels up to 2000ppm.

Step 1: Feed Water Connection

The RO system must be connected to the COLD water supply only!

1. Locate the **Cold** water supply valve under the kitchen sink (the round or oblong handle on the right side). Turn off the incoming cold water completely by turning the shut off handle clockwise.

Note: If the cold water shut off valve can not turn off the water, the main water supply to the house must be shut off for the installation. Another option is to use a “self piercing saddle valve” from APEC or from a local hardware store.

2. **Feed Water Adaptor (1/2” to 3/8”):** See **Fig. 5**. The Feed Water Adaptor comes with a separate Needle Valve. The Adaptor goes inline onto your 1/2” or 3/8” cold water pipe. The Needle Valve portion screws onto the Adaptor as shown in **Fig. 5A**.



Fig. 5

- A. 1/2” x 3/8” Male-Female Water Supply Adaptor with O-ring.
- B. 1/2” x 3/8” Male-Female Converter with O-ring.
- C. 1/4” x 1/8” Male Needle Valve.

Fig. 5A - Needle Valve Installation.

Attach the needle valve (C) to water supply adapter (A). Please apply 5-6 wraps of teflon tape to needle valve prior to connecting it to the water supply adapter (A).

Fig. 5B - If your pipe has a 1/2" Connection.

By attaching the 1/2" x 3/8" converter (B) to the Male end of the water supply adapter (A), you now have a 1/2" Male and Female water supply adapter.

Fig. 5C - If your pipe has a 3/8" Connection.

By attaching the 1/2" x 3/8" converter (B) to the Female end of the water supply adapter (A), you now have a 3/8" Male and Female water supply adapter.

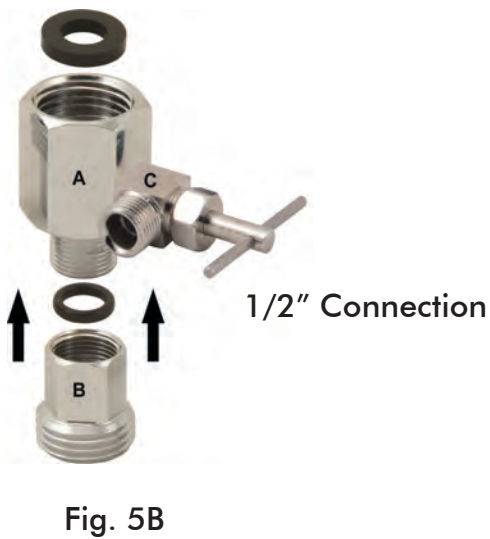

3. **Recommend Connection For Flex Line Riser:** See Fig.6A. & Fig. 6D. Loosen nut and separate cold water riser tube from faucet shank. Gently bend riser tube so that the Feed Water Adapter (Fig 5) fits onto the faucet shank. If your riser tube has no built-in washer, then fit the cone-shaped washer provided onto the riser tube. Connect the riser tube, the feed water adapter, and faucet shank together and **tighten**.

For Solid Copper Riser: See Fig.6B. Follow the same procedure as for flex line. If the copper riser cannot bend, then it's best to replace it with a flex line riser. Then fit the feed water adaptor the same way as described above.

Option Connection Point: See Fig. 6E. The feed water adapter can also be installed between the riser tube and faucet shank. Loosen nut and separate cold water riser tube from faucet shank. Gently bend riser tube so that the Feed Water Adapter fits onto the faucet shank. Connect the riser tube, feed water adapter, and faucet shank together and **tighten**.

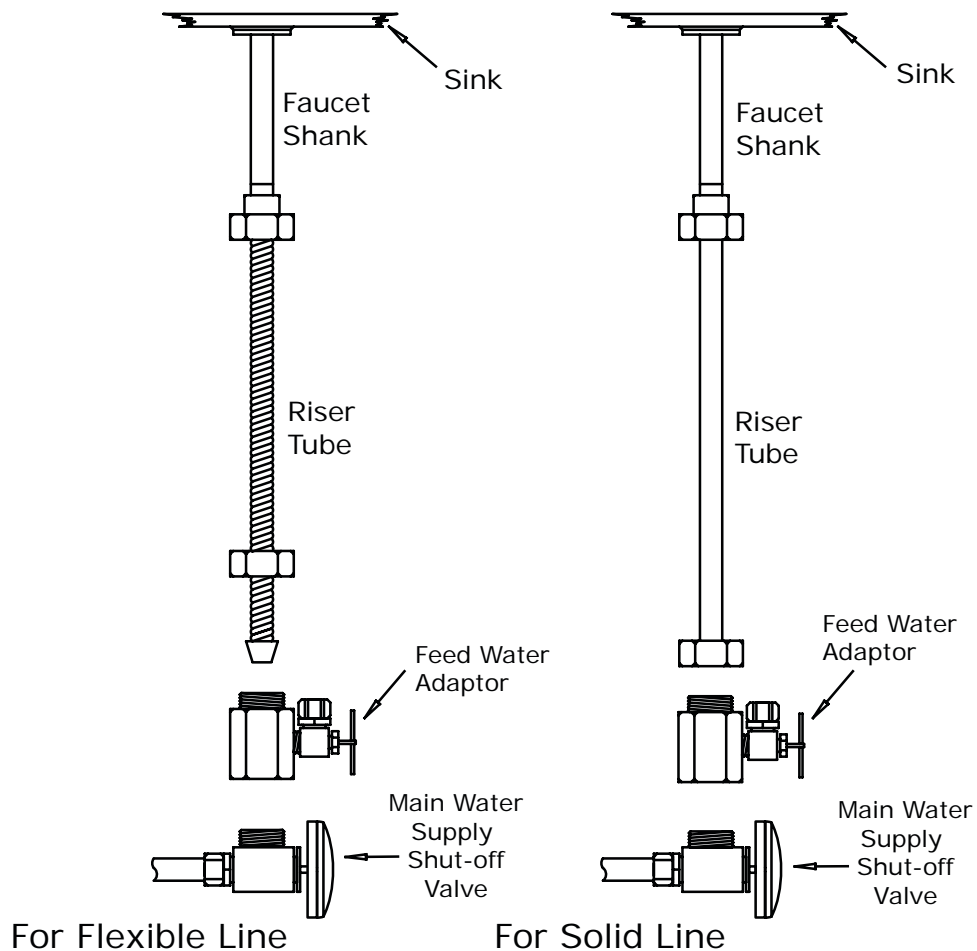

Fig. 6A

Fig. 6B

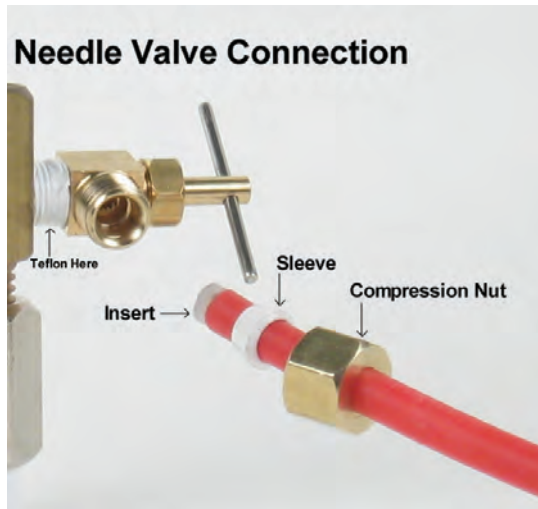

Fig. 6C

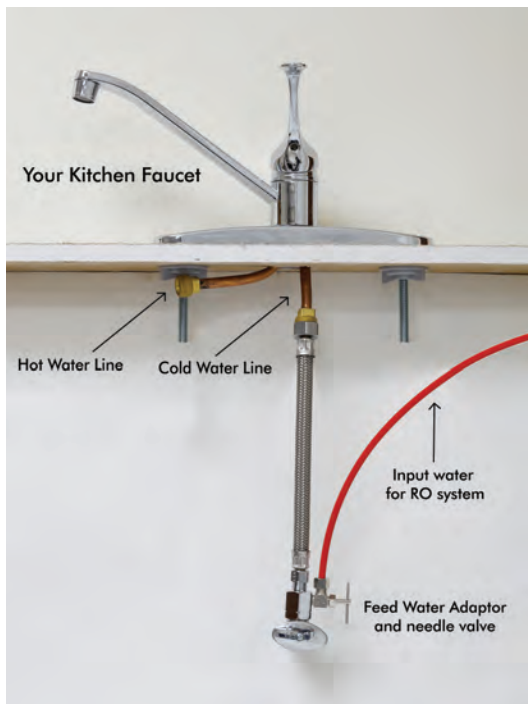

Fig. 6D

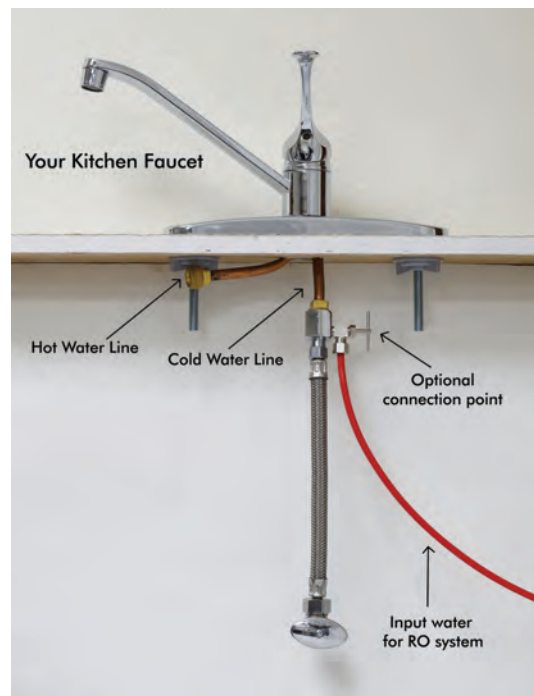

Fig. 6E

4. **Needle Valve:** See **Fig. 6C**. Screw the Needle Valve onto the Adaptor tightly. Apply 6-8 rounds of Teflon tape onto Needle Valve before attaching it to the Adaptor.

To **open** needle valve: Turn needle handle counter-clockwise.

To **close** needle valve: Turn needle handle clockwise.

Test for leaks at this point: Close the Needle Valve (turn needle handle **clockwise** all the way in to close) Turn ON the cold water supply to the sink faucet. If the Needle Valve or the Adaptor leaks, check the connection and try applying more Teflon tape or tighten the brass nut some more to stop the leak.

Step 2: Drain Saddle Installation

Note: To avoid annoying drainage noise, mount drain line as low as possible on the vertical tailpiece, or on horizontal tailpiece.

There is constant water pressure “packed” inside the RO system which blocks the waste water from backing-up into the system. So the waste water is “forced-drained”, not “gravity-drained”.

1. See **Fig.7**. The drain saddle assembly should be installed above the trap and on the vertical or horizontal tailpiece . To reduce the drainage noise, mount the drain line as low as possible above the trap, or on the horizontal tailpiece.

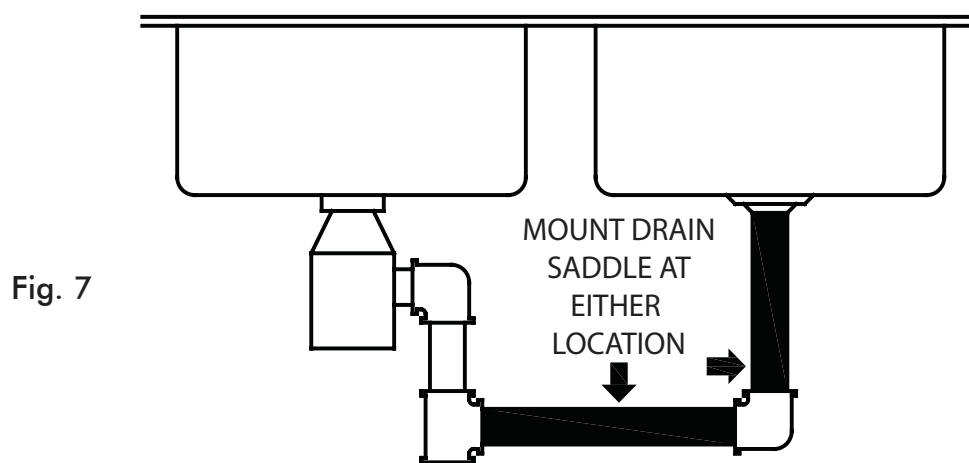

2. See **Fig.8**. Mark the position of the hole on the drain pipe and drill a 1/4" hole through one side of the drain pipe . There is a piece of self-adhesive sponge provided. Glue this sponge to the inside of the saddle, this will cushion any gap between the saddle and the pipe. Make sure the hole on the sponge is thoroughly punched out, and is aligned to the hole on the saddle.



3. See Fig.9, 9A. Make sure to align the drain saddle hole to the drilled hole perfectly. Mis-aligning these two holes will block the waste water and cause membrane damage. Attach the drain saddle to the drain pipe and tighten the two screws evenly.



Fig. 9A

Step 3: Drill A Hole For The RO Faucet

Drill 1/2" diameter hole for standard RO faucet. (Air-Gap faucet: drill 1&1/4" hole.)

For best results use a 1/2" carbide-tipped masonry drill bit.

Wear safety glasses to protect your eyes while drilling the faucet hole.

Note: No need to drill a hole if an existing hole is available:

- a) **Spare hole:** If there is a spare hole in the sink covered by a chrome cover, simply remove the chrome cover and install the RO faucet there.
- b) **Spray hose:** If the spray hose is not in use, remove the hose, and mount the RO faucet there. Remember to plug up the outlet under the main faucet. If the spray hose uses a diverter at the base of the spout, be sure to remove it to avoid trouble later on.
- c) **Hanging faucet:** If drilling a hole is not feasible (i.e. rental home, drill tool not available etc.), the faucet can just on the cabinet door or wherever that is convenient. Be creative!

When drilling a hole for the RO faucet, choose a location that looks good, works well, and is most convenient for dispensing pure water. An ample flat area is required for the faucet base so that the faucet can be drawn down tightly.

1. **Faucet location:** Make sure the faucet stud will be accessible from below when the hole is drilled. If space is not available on the upper sink area, the faucet can be located on the counter top by the edge of the sink. If the counter top is ceramic tile, the method for drilling the hole will be the same as for porcelain sinks.
2. **For Stainless Steel Sink:** Before using a 1/2" carbide drill bit, an indent should be made with a center punch to keep the drill bit from walking. A small pilot hole will also aid the drill bit.

3. **For Porcelain Sink:** Porcelain enameled sinks can readily be chipped if care is not exercised when drilling the hole. Before starting the drill motor, apply firm downward pressure on the bit until a crunching occurs. This will help keep the drill bit from walking when starting the hole. A small pilot hole will also aid the drill bit.

Note: Immediately after the hole drilling is done, clean up all metal chips, as **metal chips will stain the porcelain!!**

Step 4: Mounting The Faucet

1. Mount the faucet as shown in **Fig.10**.
2. Attach threaded end of faucet adapter to the faucet metal stem. No teflon tape needed here.
3. Connect the **Clear** line to the faucet.
3. The faucet has a solid metal handle that controls the flow of purified water exiting the faucet. Turn the handle to horizontal position to release the water and vertically to shut off.

Fig. 10

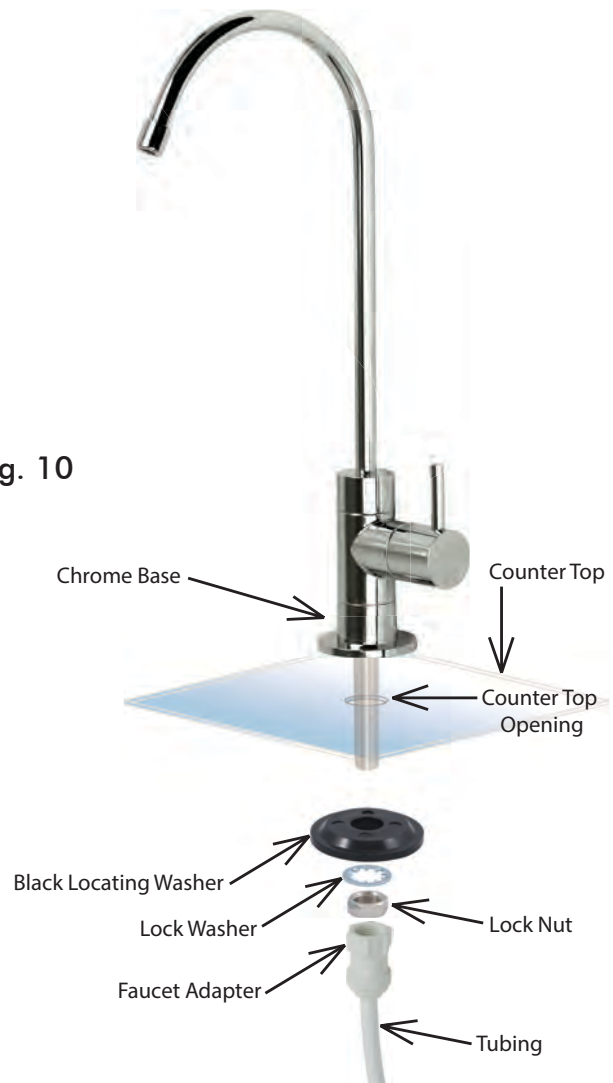

Step 5: Positioning The System

1. **Main System:** The main system can stand in the sink cabinet. No need to mount the system to the wall. If you prefer to mount the system to the wall, please make sure it can be taken down easily for filter replacement.
2. **Tank:** The storage tank can also lay on its side if needed. The tank works fine in this position. If the tank cannot fit under the kitchen sink, it can be placed elsewhere up to 20 feet away from the RO system without much pressure loss.

Step 6: Connecting The System

Summary of Tubing Connections:

There are 4 connections: See Fig 11 and 11A

Point **A** to **X**: Connect RO to COLD water supply — **Red** tubing.

Point **G** to **Y**: Connect product water from 5th-stage filter to tank — **Yellow** tubing. This tubing is a 2-way line, Product water enters and leaves the tank via this line.

Point **H** to **Z**: Connect product water from 5th-stage output to RO faucet — **Clear** tubing.

Drain line to **W**: Connect waste water from 4th-stage membrane to drain outlet — **Black** tubing.

Please Note: The diagram below is for our Non Pump RO-45, RO-90 and RO-PH90. If you are installing the RO Perm or RO Pump, please refer to the diagram in the addendum.

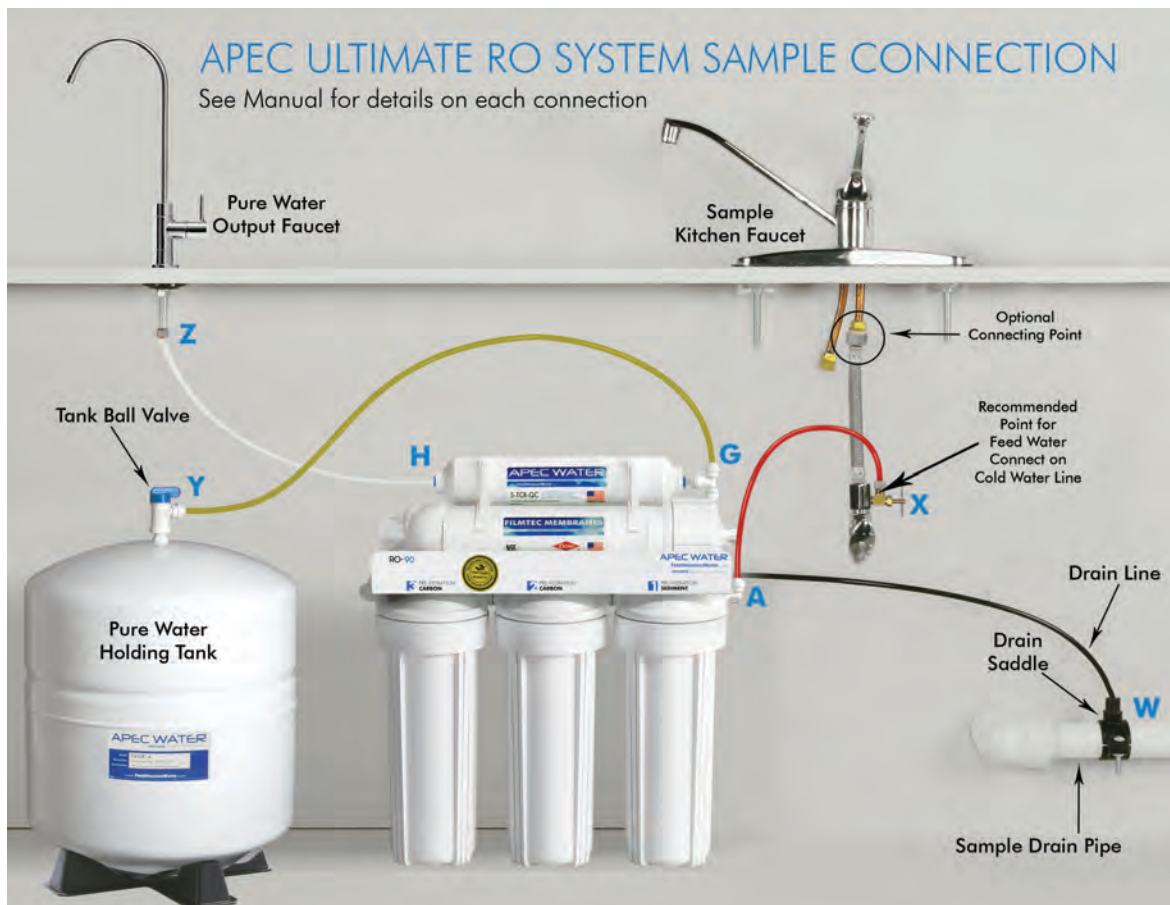

Fig. 11

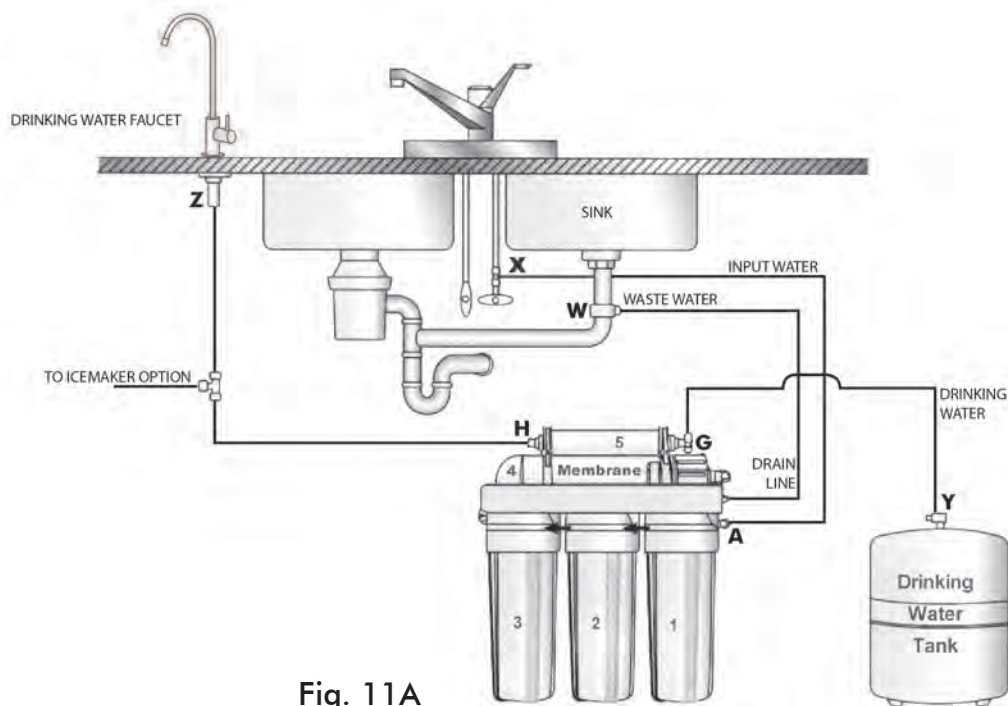

Fig. 11A

Details on Tubing Connections:

To ensure a smooth and correct installation, please connect the water lines **following the sequence and order** outlined below. Refer to **Fig.11 & 11A** for proper point locations.

1. Point Z Faucet connection:

Tubing color: Clear tubing. Connect the CLEAR tubing to the base of the RO faucet.
 Fitting type: Quick Connect Fitting. Simply push Clear tubing into Quick Connect fitting. No Insert, Sleeve or Nut needed here. (Attach threaded end of faucet adapter to the faucet metal stem. No teflon tape needed here)

2. Point X Feed water connection:

Tubing color: Red tubing. Connect the RED tubing to the Feed Water Needle Valve.
 Fitting type: Metal compression nut fitting. See **Fig.1B** on **page 4**. Use **plastic sleeve**. Add **"insert"** to tubing. No teflon tape here. Tighten nut with wrench.

Tips! If **Point X leaks** after you have tightened the brass nut, check to make sure you did put the plastic **"insert and sleeve"** onto the tubing. If the insert is already in place, then try applying Teflon tape from the threaded metal stud all the way to the plastic tubing, wrap the whole connection with 8-10 rounds of Teflon tape. Smooth out the tape on the threaded part with your fingers. Tighten brass nut again. This should stop the leak.

If the plastic sleeve is damaged, you can use the metal sleeve, but you need to apply Teflon tape as described above, this should stop the leak.

3. Point W Waste water connection:

Tubing color: Black tubing. Connect the BLACK tubing from the RO to the Drain Saddle.

Fitting type: Quick-Connect fitting on drain saddle. No teflon tape.

Do Not add "insert" into Black tubing. Simply push tubing into port.

4. Point A System water inlet (to Stage 1 prefilter) connection:

Tubing color: Red tubing. Connect the RED tubing from the Feed Water Valve to the RO's stage -1 prefilter.

Fitting type: Quick Connect fitting **See Fig.1** on **page 4**. Simply push the Red tubing into the Quick Connect fitting. No Inserts, Sleeves or Nuts are needed to secure the connection. No teflon tape needed here.

5. Point H Stage-5 filtered water to faucet connection:

Tubing color: Clear tubing. Connect the CLEAR tubing from the faucet base stud to the Stage-5 filter's outflow end at **point H**. (See "Flow -->" arrow on the filter for flow direction.)

Fitting type: Quick Connect fitting **See Fig.1** on **page 4**. Simply push the Clear tubing into outlet on the 5th stage filter. No Inserts, Sleeves or Nuts are needed to secure the connection. No Teflon tape needed here.

Please Note: *There are two end plugs on the stage 5 filter that has to be removed before inserting the tubing. Please refer to Fig. 1A on page 4 for removal instruction.*

6. Point G Stage-5 filter's T-fitting connection:

Tubing color: Yellow tubing. Connect the YELLOW tubing to Stage-5 filter's T-fitting.

Fitting type: Quick Connect fitting **See Fig.1**. Simply push the Yellow tubing into the 5th stage filter's T Fitting. No Inserts, Sleeves or Nuts are needed to secure the connection. No Teflon tape needed here.

(Note: If the unit comes with a **UV Light**, connect the Yellow tubing to the T- fitting on the UV, as the Stage 5 filter will not have a T-fitting).

7. Point Y Tank's input & output connection:

Prepare tank: See **Fig.12**. Apply 6-8 wraps of Teflon tape to tank's threaded Output stem on top of tank (remove rubber cap if there is one). Screw tank Valve onto Output stem.

Tubing color: Yellow tubing. Connect the YELLOW tubing from Stage-5 T-fitting to the tank's valve.

Fitting type: Quick-Connect fitting on ball valve. Simply push Yellow tubing into valve port.

Air pressure: The 4 gallon tank comes **pre charged** at 5 psi, 14 gallon tank at 7 psi.

Standard 4-gallon Tank Diagram:

Fig. 12



Tank Ball Valve



OFF Position



ON Position

Option: Ice-maker Connection

If you want to connect product water from the RO to your ice-maker, you will need:

- One T-fitting, preferably the quick-connect type fitting
- Extra 1/4 " tubing long enough to go from the RO system to your ice-maker
- Optional: One shut-off valve, preferably the quick-connect type.

See **Fig.13**. Before connecting the product water line from Point **Z to H**, add a T-fitting near point **H** to divert product water to both the ice-maker and the faucet. It is best open the line to the ice maker **after** the first tank has been discarded and the 2nd tank has completely filled.

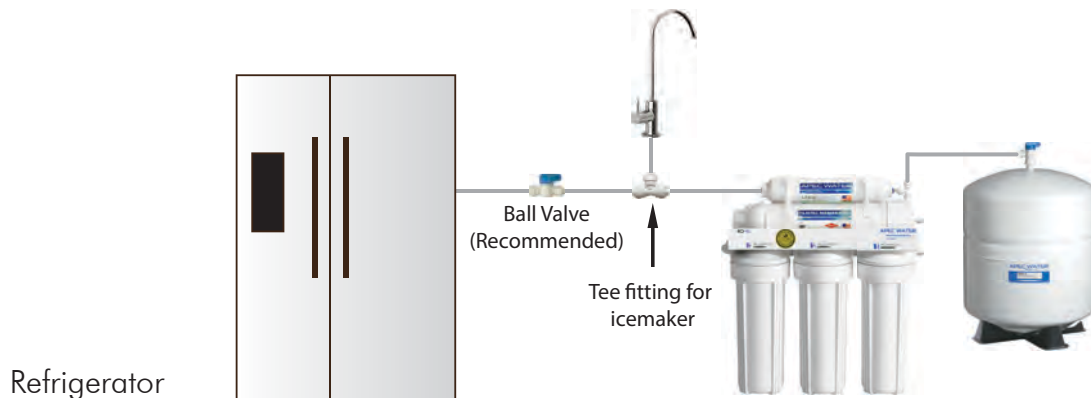

Using RO for Ice-maker only:

If you want the RO to feed your ice-maker (fridge) only, **you should still connect the RO faucet as a 2nd outlet**. This allows you to drain the tank, flush new filters through the faucet rather than through your icemaker line. You can hang the faucet by the system and not mount it.

Option: Multiple Outputs - Add Shut Off Valve:

If your RO is feeding several output points (icemaker, fridge, bathroom), you should add a **Shut-Off valve** to each output line (except the RO spigot line). This way, if you ever need to diagnose a problem in the system, you can easily shut off these lines to isolate the water flow for accurate troubleshooting.

Step 7: System Start-Up

1. **Turn on feed water:** Slowly, turn on your Cold water supply. Turn on the Needle Valve (turn counter-clockwise) to allow the raw water to enter the system. **Check for leaks!**
2. **Turn on tank valve:** Turn on the tank's ball valve to allow water to enter the tank. The tank's valve is "On" when the valve handle is parallel (in the same direction) with the valve's outlet (see Fig.12). **Check for leaks!**
3. **Wait for tank to fill:** Before usage, allow the tank to fill. Tank normally takes **2-3 hours** to fill. When the tank is filled, the RO will shut off automatically.
4. **Drain Tank:** **Do not use the first tank of water! Drain it out to flush the system and new filters.** Lift the faucet lever up into a locked position to drain tank. Let the tank refill again and the pure water is ready for use.
5. **Clean up area:** Allow the system to run while cleaning up tools and work area.
6. **Check for leaks!** Make sure **no leaking** at joints, fittings, valves, and tubing connections.

Congratulations! You have successfully installed the Reverse Osmosis System!

Note: If your RO makes an annoying noise. See Troubleshoot Guide section for explanation and instructions on page 29.

* * * End Installation Section * * *

SYSTEM MAINTENANCE

The system requires very little maintenance. Just change the filter cartridges regularly as suggested below. Keep the system indoors away from extreme heat or cold temperatures, and run the system within its reasonable output capacity (i.e. allow the system to rest at least a few hours a day).

*To properly maintain your APEC drinking water system,
please use only genuine APEC Water replacement filters at
www.FreeDrinkingWater.com/filters*

Stages 1, 2, 3 Pre-Filters:
(FILTER-SET)

Replace every 12 months.

(Private well water source: may need to replace pre-filters sooner than 12 months due to heavy sediments and other particles.)

Stage-4 Membrane:
(MEM-90) use MEM-45 for pump models

City Water: Replace every **3-5 years** depending on input water quality, water usage, and prefilter change maintenance

Private Well Water: Replace every **2-3 years** depending on well water quality, and prefilter change maintenance.

Stage-5 Carbon Filter:
(5-TCR-QC)

Replace every 3-5 years: It's best to replace this filter when replacing the stage-4 membrane.

Filter Housing O-rings:

We recommend that the filter housings O ring be replaced every **3-5 years**.

Important!

It is important to change the 3 pre-filters timely, at least every 12 months. The pre-filters protect the stage-4 membrane. If they are not changed timely and become over-depleted, the membrane will be damaged and the RO system will be contaminated.

It's best to use APEC replacement filters. Using "non APEC" and lesser quality filters may clog up the RO system and damage the membrane.

We recommend that the plastic filter housings be replaced periodically: every 5 years for the clear housing and opaque housing.

FILTER CHANGE INSTRUCTIONS

How To Replace Stages 1, 2, 3 Pre-Filters:

- 1) Turn OFF cold water supply to RO system. Turn OFF tank's ball-valve. Lift up RO faucet lever briefly to relief the built-up pressure inside the RO system. This will make opening the housings easier.

- 2) Open housing: Have the RO standing upright. Slip the plastic wrench onto the #1 housing. Looking down from a top view, you should open the housing turning **clockwise**. If necessary, lay RO down on the floor to get a better leverage. If the housing is too tight, use a hammer and tap on the wrench handle to help turn the wrench.
- 3) Discard 3 used filters, wash housings with mild soap, rinse off. Put 3 new filters into their respective housings: sediment filter in stage-1, carbon block filters in stages 2 & 3.
- 4) Close up the housings. Make sure each housing has a **black O-ring** in the thread groves. Use wrench to tighten each housing.
- 5) **Remember: Turn ON the cold water supply and OPEN the tank valve after finished changing filters!**
- 6) **Check for leaks!**

After taking the housing off, take out the dirty filters and put the new 3 pre-filters in. Remember, Stage 2 and Stage 3 are the same carbon filters.

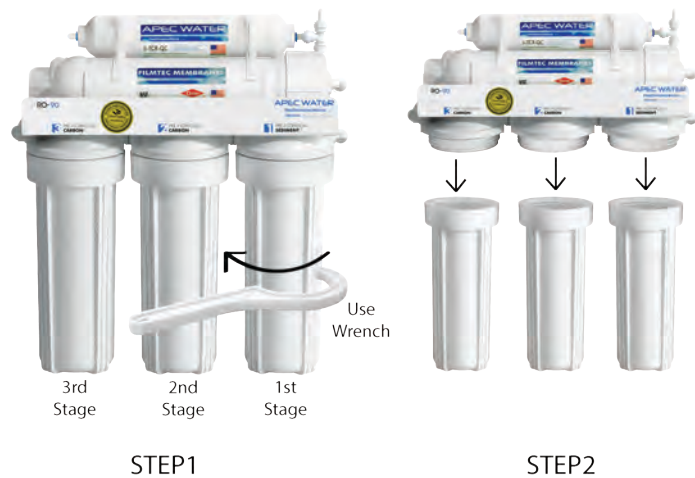

Fig. 14

How to Replace Stage-4 Membrane:

- 1) Turn OFF the cold water supply to RO system. Turn OFF tank's ball-valve. Lift up RO faucet lever briefly to relief the built-up pressure inside the RO system. This will make opening the housings easier.
- 2) See **Fig. 14A**. Locate the Membrane housing on the system (labeled "Membrane"). Remove the White tubing from the housing's cap at **point D**. Do so by Pushing In and Holding Down on the collet ring into the elbow fitting, then pulling out the tubing at the same time. (Do not remove the L-shaped fitting). Open up the cap (turn counter-clockwise). Remove the used membrane. Discard. Insert the new membrane using a pair of pliers. Push membrane into housing tightly. Avoid touching the Membrane with your hands to prevent contamination!
- 3) Important! Make sure the "double-ring" end of the membrane goes into the housing first as shown in **Fig. 14B** below. The membrane cannot filter water if it's inserted in the **WRONG** direction!
- 4) Close the housing cap. Reconnect the White tubing to the cap. **Turn on** the cold water supply and **open** the tank valve. Let the RO system run to re-fill the tank (takes about 2-3 hours).

- 5) Check for leaks!
- 6) **Drain the first tank of water (through faucet) to flush out the new membrane!** The 2nd tank of water is ready for use.

Fig. 14A



Fig. 14B



How to Replace Stage-5 Carbon Filter:

Replace this last filter at the same time you replace the stage-4 membrane.

- 1) Remove the OLD filter: See **Fig. 14 A**. Disconnect the output tubing from **point H**. Remove the T-fitting from filter's Left hand port. (**point J**). Discard the used filter.
- 2). The new Stage 5 carbon will come with two end plugs on the stage 5 filter that has to be removed before inserting the tubing. Please refer to **Fig. 1A** on **page 4** for removal instruction.
- 3) Use some mild bleach solution to rinse the Tee-Fitting and Tubing end. This is to prevent contamination.
- 4) Connect the Tee-Fitting to **point J** and pure water output tubing to **point H**. Make sure the "FLOW →" on the filter is pointing to the pure water **output direction**. Only this filter change needs bleach sanitizing. **Do Not** apply chlorine/ bleach in anyway to Membrane for it will damage the membrane!
- 5) **Check for leaks!**

*** End Filter Change Section ***

OWNER'S MANUAL

Please read this section for useful RO system and maintenance information.

TABLE OF CONTENT

Part I: RO Basics

Basic terms	page 23
System flow diagram	page 23
Water pressure -- The most important factor	page 24
TDS meter -- How to test your water quality with meter	page 24
Tank -- Fill up time. Fill up volume. Delivery pressure	page 24
Icemaker and multiple output points	page 26
Insufficient water Pressure -- Problems with non-pump systems	page 26
How to test your water pressure	page 27
Premature membrane failure	page 27

Part II: Trouble-shoot Guide

RO Head diagram	page 28
Humming noise	page 29
Slow output	page 31
System shut off abnormal	page 31
TDS level higher than normal	page 33
Filter housing is leaking	page 34
Tank ball valve is leaking	page 35
Pure water still tastes like Tap water	page 35
Air Bubbles: Lots of Air bubbles in cup or bottle when filling	page 35

Part I: RO BASICS

This section provides basic concepts on how an RO system works, how it performs in relation to your house's water condition. We hope this information helps keep your RO system running at top performance for years to come.

1) Basic Terms

GPD = Gallons Per Day (flow rate)

PSI = Pounds per Square Inch (pressure)

TDS = Total Dissolved Solids (contaminants)

PPM = Parts Per Million (unit used to measure TDS level)

TDS Meter = A digital meter for measuring the TDS level in the water

2) Flow Diagram for 5-Stage RO System:

Fig.15 below shows how water flows through the RO system from Feed point to Output point.

Input water starts from Main Water Supply, going through stages 1, 2, 3 pre-filters, then enters the stage-4 membrane. Product (filtered) water from the membrane feeds the storage tank; the "brine water" from the membrane drains out through the drain line. Product water from the tank passes through stage-5 filter before reaching the dispensing faucet.

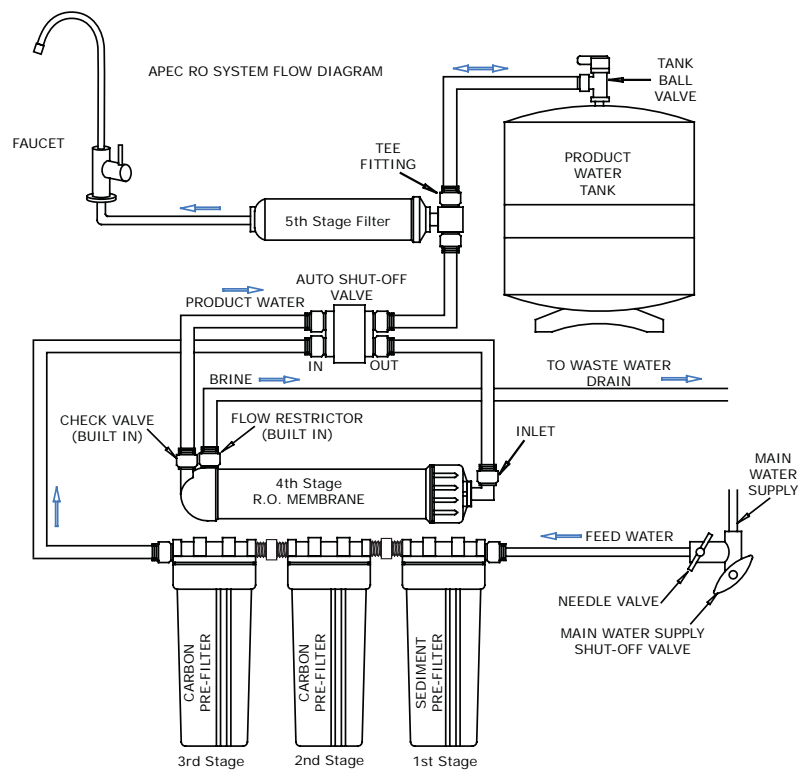

Fig. 15

3) Water Pressure – The Most Important Factor!

RO systems run on water pressure. Therefore your water pressure has the most direct effect on how well your RO will perform. With sufficient water pressure (85 psi max.), your RO system will function well, give high output with high rejection rate, and fill up the storage tank quickly.

4) TDS Meter (Option) -- How to Test Your Water Quality:

The TDS meter is used to test your water's quality before and after the RO system. It also tells you when the membrane needs to be changed.

Please follow instructions below:

Use 2 clean glasses, fill one glass with Tap water, fill the other glass with Product (filtered) water (rinse this glass with filtered water several times to get an accurate reading). Remove the Sensor cap on the TDS meter and rinse the meter sensor with filtered water several times, then Turn on the meter.

The meter will show "000" reading on its screen. Place the TDS meter into the Product water. Record Product water's TDS reading. Then do the same for the Tap water. Record the Tap water's reading. Compare the 2 readings.

The Product water's TDS should be about 3%-10% of your Tap water's TDS. This is a normal range.

For example:

Your Tap water's TDS: 100 ppm

Your Product water's TDS should read within: 10% of 100ppm => 10ppm

This means that with 100 ppm input, the RO system has removed 90% of the contaminants (TDS) from the source, leaving only 10% (10 ppm) residual TDS in the Product water. This is a normal range. Which means the RO membrane is in good condition.

If your Product water TDS reads less than 10%, that is a very good and normal reading.

You should test your water once or twice a year to monitor the membrane condition. As the membrane gets depleted overtime, its rejection capacity will decrease. When this happens, the TDS in the Product water will increase.

When your Product water TDS creeps up to 15%- 20% of input water's TDS, it's time to replace the membrane.

5) How Long Does It Take to Fill Tank?

Depending on your water pressure, the standard tank will fill up in 2-3 hours. After the tank is filled, the RO will shut off automatically.

6) How Full Can My Tank Fill Up?

Your incoming **water pressure** determine how full and how fast the storage tank will be filled up. The stronger your input water pressure, the faster and fuller the tank can fill. If water pressure is low, the tank will fill slower and will not fill up to its full capacity.

For a **Non-pumped** RO system:

The **4 gallon tank*** will fill up according to your input water pressure as follows:

Input	70+ psi	—>	tank fills	3.1 gallon	(almost 100% full)
Input	60 psi	—>	tank fills	2.8 gallon	(about 88% full)
Input	50 psi	—>	tank fills	2.5 gallon	(about 70% full)
Input	40 psi	—>	tank fills	1.9 gallon	(about 50% full)

The **14 gallon tank*** will fill up according to your input water pressure as follows:

Input	70+ psi	—>	tank fills	9.7 gallon	(almost 100% full)
Input	60 psi	—>	tank fills	9.0 gallon	(about 88% full)
Input	50 psi	—>	tank fills	7.8 gallon	(about 70% full)
Input	40 psi	—>	tank fills	6.1 gallon	(about 50% full)

So, if your input water pressure is low, the tank will not fill up to full.

* 4-gal and 14-gal refer to tank's total volume (air space & bladder). At 80-90psi, tank bladder's capacity is around 3.2 gallons for 4-gal tank, and 10.3 gallons for 14-gal tank.

7) How Much Pressure Can RO Deliver to My Ice-Maker?

The RO's delivery pressure depends on how full the tank is. The pressure is high when tank is full, and drops when tank depletes. See charts below for 4gal tank and 14gal tank.

4-gallon tank's delivery pressure:

3.0 gallon	—>	50 psi output/delivery pressure (pressure inside tank)
2.5 gallon	—>	36psi
2.0 gallon	—>	24 psi
1.5 gallon	—>	18 psi
1.0 gallon	—>	14 psi
0.5 gallon	—>	10psi
Tank empty	—>	5 psi (pre-charged pressure)

14-gallon tank's delivery pressure:

10 gallons —> 50 psi output pressure (pressure inside tank)
9.0 gallon —> 40 psi
7.8 gallon —> 30 psi
6.1 gallon —> 20 psi
3.3 gallon —> 14 psi
1.6 gallon —> 10psi
Tank empty —> 7 psi (pre-charged pressure)

8) Ice-Maker Inlet Pressure Requirement:

If your ice-maker requires a *minimum* input water pressure of 20-30psi, you need to have at least 50+psi input water pressure going into your non-pump RO system. If your water pressure is under 50psi, the tank will not fill up enough, and the delivery pressure to your ice-maker may be sluggish and unstable. To boost output pressure, you can add a Permeate Pump to your RO system.

9) Feeding Multiple Outlets:

Feeding the filtered water to multiple outlets is do-able. The key is choosing the right RO model that fits your house's water pressure level. This model should fill up the tank quickly and fully. A frequently full tank will then provide good delivery pressure to feed the multiple outlets in your house. You should get the 14 gallon tank upgrade, this bigger tank holds 3 times more water than the standard 4gal tank. It will give you the extra water and delivery pressure you need to feed the remote points.

We suggest limiting output points to no more than 3 outlets. Total tubing distance should be within 40 ft. horizontal and 15 ft. vertical from the RO system.

10) Insufficient Water Pressure – Problems with Non-Pump RO Systems:

The 3 most common problems caused by low input water pressure:

- 1) Tank does not fill up, get little water from tank
- 2) Sluggish flow at the dispensing faucet
- 3) RO makes water slower than the claimed GPD

If you experience these problems, ***Please check your input water pressure as the first step.*** This will often solve the above listed problems.

11) How to Test Your Water Pressure:

Get a water pressure gauge that adapts onto your sink or garden faucet (from hardware store), attach gauge onto faucet, turn water on to FULL, then take a reading.

For some areas, water pressure is lower during the day and higher at night when less people are using water. So to get an accurate average, take several measurements at different times of the day and average them out.

12) Premature Membrane Failure:

There are 4 common causes that lead to premature membrane failure:

1. Failing to replace the 3 pre-filters as frequently as needed:

If you're on city water: The over-depleted carbon pre-filters allow the chlorine to get through and damage the membrane.

If you're on private well water: The overloaded pre-filters allow excessive sediments and particles to get through and clog up the membrane surface.

2. Your water source may contain certain organic or chemical compounds that form a slimy film which covers up the membrane's surface. This will disable the membrane prematurely. In this case, adding a UV light could help extend the membrane's life.
3. Your water source is extremely hard. This will clog up the membrane with heavy calcification. Adding a water softener will help greatly.
4. If the waste water flow is somehow restricted or blocked, the membrane will be damaged prematurely. So please check to make sure the waste water is draining off unhindered.

* * * End RO Basics Section * * *

Part II: Trouble-Shoot Guide For Newly Installed RO System

After installation, if you encounter any of the problems described below, please follow this guide to troubleshoot. In most cases, the problem is quickly solved by following this guide.

Non-Pumped RO HEAD DIAGRAM



Fig. 16

RO Head Points Identification:

- Point A:** Feed water inlet into Stage-1 filter
- Point B:** Stage-3 filter's **output** port
- Point C:** Automatic-Shut-Off (ASO) valve. For Permeate Pumped systems, the permeate pump replaces the ASO valve, it serves both as a pump and an auto-shut-off valve.
- Point D:** Stage-4 Membrane housing **inlet** port. Feed water from Stage-3 filter enters the Membrane at this port.
- Point E:** Check Valve. The filtered water from the Membrane passes through this Check Valve before entering the storage tank. The Check Valve blocks the tank water from back-flowing into the membrane.
- Point F:** T-fitting on Stage-5 filter. This end of the T-fitting connects to the CLEAR pure water line.
- Point G:** T-fitting on the Stage-5 filter. This other end of the T-fitting connects to the YELLOW pure water line which goes to the tank's valve.
- Point H:** The **output end** of Stage-5 filter. Pure water leaves Stage-5 filter via this port, and flows onto the dispensing faucet.

1) RO Makes Humming Noise

When RO makes a humming noise, most likely it's caused by air bubbles being trapped in the "Check Valve" during installation. See check valve on **Fig.16**, point **E**.

To purge air from the check valve, do as follows:

- Step 1: Close the tank's valve.
- Step 2: Tilt the RO system **to the right**. Put something under the 3rd filter housing to keep RO tilted. This helps dislodge the air bubbles from the Check Valve.
- Step 3: Turn **on** the RO spigot. Let pure water flow through the spigot for **about 1 minute**. This forces the air to flow directly out to the spigot, bypassing the tank.
- Step 4: Turn **off** the spigot. Wait for about 10 seconds. Repeat **Step 3** again. Do that 3-4 times. If you see air sputtering out of the spigot, repeat Step-3 until pure water can flow smoothly from the spigot, or until the noise goes away.
- Step 5: When the noise is gone, open the tank valve, let RO run as usual.

Fig. 17

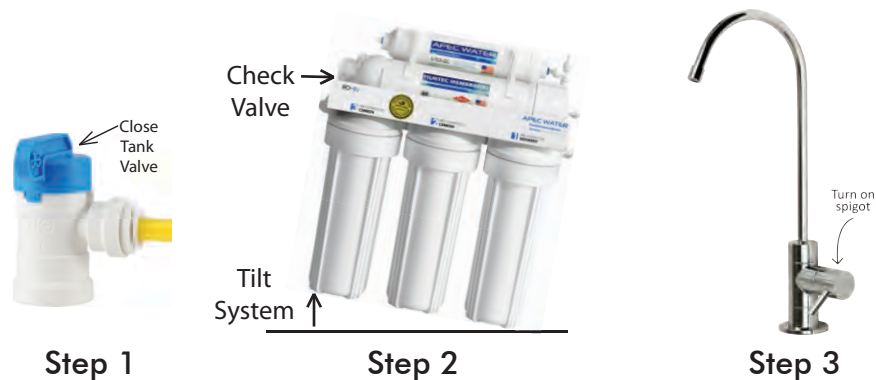

If the noise comes back, try the above procedure again another 2- 3 times. Sometimes it takes several tries to get rid of all the air in the system.

If the noise persists after a few days, that means there is air in your water source, or the current Check Valve is resonating with your water pressure and pipes, creating the noise.

In this case, a new Check Valve will solve the problem. Contact APEC customer service for assistance.

2) No Water at Dispensing Faucet

- Water supply is off —> Turn on water, or open Needle Valve
- Tank's valve is closed —> Turn tank valve to an "Open" position

- Output line is crimped —> Remove crimp
- Incorrect installation —> See **Fig.11 & 11A**. Verify all line connections.
- Tank defective, no pre-charge pressure —> Set tank pre-charge to 5-7 psi.
- ASO connection Error —> See **Fig. 18A** and **Fig. 18B** to reconnect ASO to the correct connection.

The **ASO valve** has 4 lines connected to it, 2 Whites and 2 Clears. C1 is labeled IN and C2 is labeled OUT on the valve. C3 and C4 are connected to the ends with the 4 screws. Please confirm connections:

- Stage 3 Carbon: White tubing (**point B**) is connected to **C1 (IN)** fig.18A
- Membrane: White tubing (**point D**) is connected to **C2 (OUT)** fig.18A
- Check Valve: Clear tubing (**point E**) is connected to **C3** fig.18B
- 5th stage Tee inlet: Clear tubing (**point F**) is connected to **C4** fig.18B



Back View
Fig. 18A



Front View
Fig. 18B

3) Sluggish Flow At Dispensing Faucet

- Insufficient water pressure (see “RO Basics” for explanation) —> Check water pressure. If too low for this chosen RO model, either increase your water pressure or add pump to RO system.
- Input water to RO is blocked —> Make sure Feed water valve is fully opened and unhindered.
- Tank not filled yet —> Wait until tank is more filled, takes **2-3 hours** average.
- Low tank pre-charge pressure —> Raise tank pre-charge to 5-7 psi.

4) Tank Takes Long Time To Fill (does not meet claimed GPD)

- Insufficient water pressure (below 60 psi for non-pump systems) —> Increase house water pressure or add an appropriate pump to system.
- Low water temperature (below 77 degree F) —> Increase house water pressure or add pump to compensate for low (cold) water temperature.

Claimed GPD:

The claimed gallon per day (GPD) flow rate for each RO model is rated based on **60 psi** input water pressure at **77 degree F** water temperature. At this standard water pressure and temperature, the RO-90 gpd system should make about 3.7 gal of filtered water per hour, the 4-gal tank should fill in 1-1.5 hours.

Lower water pressure and colder temperature will slow the system’s output to less than the claimed GPD flow rate. ***Please check your water pressure as the first step in determining the cause of slow flow rate (low GPD).***

5) System Slow Shut-Off: Waste water runs for hours (6-7 hrs) - but Eventually Stops

The most common cause for “slow-shut-off” is insufficient input water pressure. RO needs sufficient input pressure to shut off promptly.

- Input water pressure too low (below 40psi). Not enough pressure to shut off RO promptly —> Check input water pressure. If pressure is low, boost house pressure or add pump to RO.
- Feed water valve partially blocked, not opened fully, reducing input water pressure to RO —> Check and fix feed water valve, make sure it is opened fully to allow maximum pressure to RO.
- Stages 1, 2, 3 pre-filters partially clogged, reducing the input water pressure in RO —> Check stage-1 filter to see if it’s very dirty. If this filter has turned brown or other color in just **1-3 months**, that means your input water has very heavy sediments and other clogging agents. Need to replace stage-1 filter frequently.
- RO busy feeding multiple output points —> If your RO feeds multiple outlets (icemaker, bathroom, aquarium), the waste water will run as long as the RO is making water to fill the tank and other output points. In this case, it’s normal to hear waste water running.

6) System Does Not Shut-Off: Waste water runs all day - and Never Stops

- Input pressure way too low (below 30psi). Not enough pressure to shut off the RO at all —> Check input water pressure. If pressure is below 30psi, need switch to Booster-Pumped RO model. Contact APEC customer service for assistance.
- One of the shut-off valves is defective, so RO cannot shut off —> Do a shut-off test to determine which valve is defective. Do test as shown below.

7) How to Test RO's Shut-Off Function:

The RO system should shut off automatically when the tank is filled. When the RO fails to shut off after tank is filled, the waste water will keep running down the drain, depleting the pre-filters, the membrane, and costing high water bills.

See **Fig.16**. The **Auto-Shut-Off (ASO)** valve is located at **point C**. The Check Valve is located at **point E**. These two valves control the RO's shut off function.

If one of these valves fails (valve worn out, clogged, or defective), the system cannot shut off, and the waste water fill keep running non-stop.

Do test #1 and #2 below to determine if the RO can shut off, and if the valves are OK.

Test#1: Can the RO system shut off?

- Draw 2-3 glasses of water from spigot. RO will start making water to fill tank.
- Turn OFF the tank's valve to mimic "tank full".
- If your RO feeds multiple output points (icemaker, bathroom, etc), shut OFF those lines.
- Wait for 3- 5 minutes, then check to see if the waste water stops running.
- Check waste water by either "listening" or actually pulling out the drain line to look at it.
- If waste water **stops running** --> The RO is shutting off properly. Both the ASO valve and the Check Valve are working fine. Stop testing.
- If waste water **continues to run** --> Then *either* the Check Valve and/or the ASO valve is defective. Proceed to **Test #2**.

Test#2: Test Check Valve and ASO valve:

- Make sure there is some water in the tank (tank not empty).
- Remove the Black drain line from the drain saddle (so you can check waste flow drainage).
- Turn OFF the Cold feed water supply.
- Turn ON the tank valve.
- Check the Black drain line to see if there is any water draining out from this line.
- If **water does drain out** from the black line --> Then this water is coming from the storage tank. This means the Check Valve is broken, it is allowing the water in the tank to back flow out into the drain line.
Solution: Replace Check Valve (see **Fig.16 point E**)
- If **no water drains out** from the black line (no waste water running) --> That means the Check Valve is OK. The RO's non-shut off is caused by a defective ASO valve, not caused by the Check Valve.

Solution: Replace ASO valve (located at **Fig.16 point C**)

8) TDS (Total Dissolved Solids) Level Reads Higher Than Normal

How to test TDS correctly: See "TDS Meter -- How to Test Your Water Quality" instructions on page 24.

If the filtered water's TDS reads higher than the normal 10% range, these are the possible causes:

- Forgot to insert membrane into its housing —> Put membrane into housing.
- Membrane is inserted incorrectly —> Re-insert membrane correctly. See **Fig.14B**, page 20.
- Water pressure too low, causing TDS to be higher than usual —> Raise water pressure or add pump to RO.
- Input source water has very high TDS and/or contains certain heavy dissolved elements resulting in TDS higher than usual.
- Waste water flow is restricted or clogged —> Check and re-align the drain saddle and drain line.
- Your input water's TDS fluctuates resulting in high "composite" TDS in the holding tank —> To verify this, test the filtered water's TDS before it enters the tank. Do test as follows:

Test #1 TDS from tank: Dispense some water from the RO faucet, this water comes directly from the tank. Test TDS, record the reading, then Do Test #2.

Test #2 TDS bypassing tank: Turn OFF tank valve. Disconnect the Yellow line from the tank's valve. A stream of filtered water will trickle out of the Yellow line. Let the water trickle freely for about 1 minute, then Catch some water here and do a TDS test. The TDS here is the actual "real time TDS" the RO is producing before water enters the tank. Compare this TDS reading with the tank's TDS you get in Test #1.

If tank TDS is higher than Yellow line TDS, that means your source water's TDS level fluctuates over time. So, from day to day, the TDS highs and lows accumulate in the tank resulting in a high "composite TDS" reading. This is especially true if you're on a private well. The well pump's fluctuating pressure cycles also cause TDS to go up and down. In this case, the "real-time" TDS from the Yellow line (prior to the tank) is the system's true performance. If this number is within 10% of your tap TDS, then it is within an acceptable range, and your RO system is working fine.

Drawing more water can help stabilize the TDS. If you are only drawing a small amount of water every time, the unit will quickly turn On and Off, not allowing the membrane to receive full inlet pressure, causing a spike in the TDS.

9) **Filter Housing Is Leaking**

If you are experiencing a leak from any of the pre-filter housings on the reverse osmosis system, the rubber O-ring may be defective. The filter housing must have an O-ring in order to seal properly. Please review the steps below to address a leaking filter housing.

Please follow the steps below:

Step 1. Shut off the feed water line to the RO unit. Turn off the tank ball valve by turning the Blue Cap on the tank ball valve 90 degrees.

Step 2. Use the filter housing wrench to unscrew the filter housing that is leaking. Make sure the O-ring is seated correctly inside the filter housing groove. You may also want to apply some Vaseline around the O-ring. This will help secure the O-ring in the filter housing groove.

Step 3. Re-attach the filter housing to the RO head. Hand tighten the housing, then use the filter housing wrench and simply give an additional quarter inch turn. **Do Not** over tighten the housing.

Step 4. Open the tank ball valve and feed water line. Check for leaks. If the filter housing continues to leak, please contact APEC technician for replacement assistance.



10) There is a leak at the Tank ball valve connection

If you are experiencing a leak from where the tank ball valve attaches to the tank stem, you may not have applied enough Teflon tape to the stem when you first installed the valve. To correct this issue, flush out any water that may of filled the tank, then remove the tank ball valve. Apply 6-8 wraps of Teflon Tape to the tank stem and re-attach the tank ball valve. Please double check the connection for leaks.

11) Pure water still tastes like Tap water:

The first thing to check would be if the reverse osmosis membrane was installed. The membrane is the heart of the RO unit and it is the component that removes most of the contaminants and impurities in the water. If the membrane is installed, please make sure the first 1-2 tanks of water have been completely flushed out. The new filters on your system needs to be flushed out before use.

If the tank has been flushed out, use the TDS meter to check the tap water vs. pure water TDS. RO units will remove 90-95% of contaminants and impurities in the water. If the pure water is not at 90% or higher, please contact an APEC technician for assistance.

12) Air Bubbles: Lots of Air bubbles in cup or bottle when filling

It is quite normal to see air bubbles in a cup of pure water. This mainly occurs when a RO unit is first installed or when filters are being replaced. When new filters are installed to the unit, the filter housings are dry. When they are attached onto the RO head, air pockets will fill the housing. As water is turned on and flows through the unit, the air pockets move throughout the system. This can have an effect on the appearance of air bubbles in the water.

RO units will self purge the air bubbles that can accumulate inside the unit. As you continue to draw water, trapped air will be removed by the water flow and you should quickly see a reduction in the bubbles inside the water cup. You can also drain 1-2 tanks of water to quickly purge the air bubbles.

* * * End Trouble-Shoot Guide * * *

OTHER INFORMATION

AirGap Faucet Installation

There are 3 colored tubings on your Air-Gap faucet. At the end of each 1/4" tubing there is a "Quick Connect" fitting. The Quick Connect fittings is used to connect the Pure and Waste water line from the RO unit to the Air Gap Faucet.

To connect the lines, simply insert each line into the fitting port tightly.

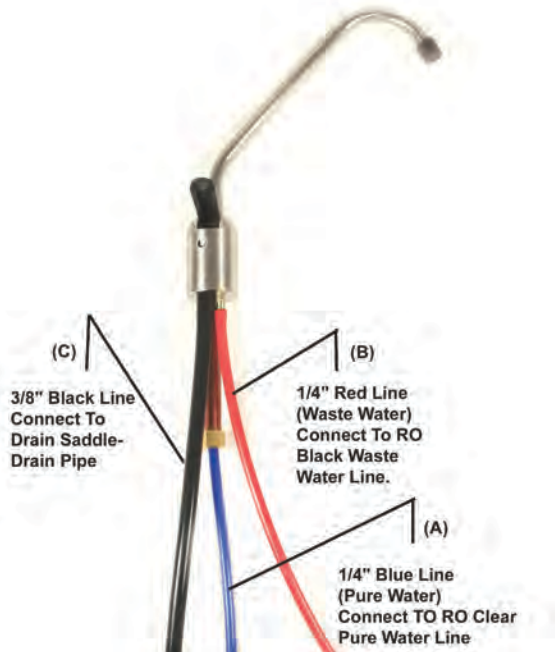

Fig. 19



Fig. 20

Hook-Up:

1. Assemble the faucet: There is a plastic "filler tube" in the slot next to the faucet's on/off black lever. Remove this filler-tube, and immediately insert the faucet spout into the slot to prevent the black lever from falling out of its socket. **Do Not press down the black lever until the spout is inserted into the slot.**

2. Please connect each tubing to your RO system and drain outlet as follows:

Blue 1/4" tubing: Connect the 1/4" **Blue** line from the Air-Gap faucet to the RO's 1/4" Output CLEAR Line (which is hooked up to the Stage-5 filter output port). **See Fig.19&20**

Red 1/4" tubing: Connect the 1/4" **Red** line from the Air-Gap faucet to the RO's 1/4" BLACK Drain Line on your RO system. **See Fig.19&20**

Black 3/8" tubing: Connect the 3/8" **Black** line on the Air-Gap faucet to the new 3/8" Drain Saddle provided. **See Fig.20**

How wastewater is disposed via Air-Gap faucet:

Waste water is routed through the Air-Gap faucet prior to being drained off into the standard drain-pipe outlet. The 1/4" **BLACK** waste water line from the RO system will discharge through the 1/4" **RED** line to the Air-Gap faucet. The waste water will then flow back down the 3/8" **BLACK** waste water line of the Air-Gap faucet to your drain pipe.

Pure water output flow:

After the Air Gap faucet is installed, the RO pure water output line will flow from the Stage-5 filter, through the **BLUE** line of the Air-Gap faucet, to the dispensing faucet.

* * * End AirGap Faucet Installation * * *

LIMITED PRODUCT WARRANTY

Scope

APEC takes pride in selling a superb line of products, including this reverse osmosis system ("Product"). As such, APEC expressly warrants to the original purchaser that, for a period of one (1) year from the date of purchase, the Product will be reasonably free of defects in materials and workmanship. Within that one (1) year period from the original purchase, APEC will, at its option, repair or replace the Product without charge, or refund the cost of the Product, if the Product fails or does not perform as warranted solely due to a manufacturing defect within the warranty period, subject to the limitations and exclusions set forth in this Limited Product Warranty. This Limited Product Warranty only applies when the Product is used, stored, handled, fabricated and/or installed in the manner recommended by APEC in the Installation Instruction & Owner's Manual ("Manual").

Repair or Replacement

Repair or replacement during this one (1) year warranty shall include reasonable labor charges necessary to repair or replace the defective Product, but shall not include freight charges or any other local labor charges from third parties other than APEC, unless APEC expressly approves such charges in writing. During the entire one (1) year warranty, APEC's obligation to repair or replace shall further be limited to repair or replacement with the styles, models, products, colors, etc. of the Product that are available at the time of the repair or replacement, and shall be limited to the repair or replacement of only the specific Product that fails due to a manufacturing defect. Any repaired or replaced product shall also remain subject to the original one (1) year warranty from the date of the original purchase, and any repair or replacement shall not extend the original warranty period in any manner or start a new warranty period.

Conditions of Validity of this Limited Product Warranty

Even though the Product has extremely high endurance for operating conditions such as pH, maximum TDS, temperature, and optimum water pressure, THIS LIMITED PRODUCT WARRANTY SHALL ONLY BE VALID IF:

1. The replaceable filters and membrane are changed and maintained on a regular basis as directed in the Manual. Moreover, depending on local water input water quality, regular maintenance may need to be increased.
2. The Product is operated within the confines of the following standard operating conditions:

	Water Pressure	pH Range	Max. TDS	Water Temperature
Standard System	40- 85 psi	2-11	2000 ppm	40-100 F
Permeate Low Pressure System	30- 85 psi	2-11	2000 ppm	40-100 F
Booster Pumped System	0- 30 psi	2-11	2000 ppm	40-100 F

Any information or suggestion by APEC with respect to the Product concerning applications, specifications or compliance with codes and standards is provided solely for your convenient reference and is made without any representation as to accuracy or suitability. You must verify and test the suitability of any information with respect to the Product for your specific application.

Non-Covered Defects

THIS LIMITED PRODUCT WARRANTY DOES NOT COVER DEFECTS CAUSED BY:

1. Improper storage, installation, maintenance, handling, use and/or alterations of the Product, including, but not limited to, non-compliance with the installation, maintenance and standard operation conditions stated in the Manual and this Limited Product Warranty.
2. Unreasonable use, unintended use, or misuse of the Product for something other than its intended purpose as a reverse osmosis system.
3. Use of replacement parts, filters, membranes or other accessories that are not sold or manufactured by APEC for use with this particular Product.
4. Damage not resulting from manufacturing defects that occur while the Product is in the original purchaser's possession.
5. Installation of the Product with known or visible manufacturing defects at the time of installation.
6. Damage caused by freezing, flood, fire or Act of God.

CONDITIONS THAT RENDER THIS LIMITED PRODUCT WARRANTY VOID

THIS LIMITED PRODUCT WARRANTY SHALL BE VOID IF:

1. The Product is not operated in compliance with normal municipal water conditions for which the particular model of this Product is intended.
2. The person seeking to invoke the warranty is not the original purchaser. That is, this Limited Product Warranty only extends to original purchasers.
3. The is purchased used. That is, this Limited Product Warranty only covers new products.
4. The Product is purchased from someone other than APEC or one of APEC's authorized dealers. This is because, unless the Product was sold by APEC or one of its authorized dealers, APEC cannot verify or guarantee the integrity or authenticity of the Product.

General Conditions

The warranties set forth herein are the only warranties made by APEC in connection with the product. APEC cannot and does not make any implied or express warranties with respect to the product, and disclaims all other warranties, including, but not limited to, any warranty of merchantability or fitness for a particular purpose. Products sold by APEC are sold only to the specifications specifically set forth by APEC in writing. Other than the limited product warranty set forth herein, APEC makes no other warranties, express or implied. APEC's sole obligation under this warranty shall be repair or replacement of a non-conforming product or parts of the product, or at the option of APEC, return of the product and a refund of the purchase price. Buyer assumes all risk whatsoever as to the result of the use of the product purchased, whether used singularly or in combination with any other products or substances.

No claim by the buyer/owner of any kind, including claims for indemnification, shall be greater in amount than the purchase price of the products in respect to which damages are claimed. In no event shall APEC be liable to buyer/owner in tort, contract or otherwise, for any special, indirect, incidental, consequential, reliance, statutory, special, punitive or exemplary damages, including, but not limited to, lost profits, loss of use, loss of time, inconvenience, damage to good will or reputation, or loss of data, even if advised of the possibility of such damages or such damages could have been reasonably foreseen, in connection with, arising out of, or as a result of, the sale, delivery, servicing, use or loss of use of the products sold hereunder, or for any liability of buyer to any third party with respect thereto.

Obtaining Warranty Coverage or General Inquiries

If coverage is available, you may obtain coverage under this Limited Product Warranty by providing APEC with proof of original purchase, and that you are the original purchaser. For service under this Limited Product Warranty, you must notify APEC by phone at 1-800-880-4808, by email at techsupport@freedrinkingwater.com, or in writing at 1320 S. Johnson Dr., City of Industry, CA 91745. In making the claim, please provide your name, address, phone number, a description of the product involved, and an explanation of the defect.



Advanced Purification Engineering Corp.

1320 S Johnson Drive
City of Industry, CA 91745

For questions or comments please visit our website at:

FreeDrinkingWater.com

For technical support contact us at:

**Techsupport@freedrinkingwater.com
1-800-880-4808**