



INSTALLATION, OPERATION AND MAINTENANCE MANUAL

Warning

Please read carefully before proceeding with installation. Failure to follow attached instructions or operating parameters may lead to the product's failure.

Save manual for future reference.

Model: WP-ST6DM REVERSE OSMOSIS SYSTEM



Thank you for your purchase of a state of the art Reverse Osmosis (RO) water treatment system. Water quality concerns are becoming more of a focus for the public. You may have heard about contaminants in the drinking water, such as Arsenic, Chromium, Cryptosporidium or Giardia. There may also be some local water issues such as high levels of Lead and Copper. This Watts water treatment system has been designed and tested to provide you with high quality drinking water for years to come. The following is a brief overview of the system.

Your Reverse Osmosis System:

Osmosis is the process of water passing through a semi permeable membrane in order to balance the concentration of contaminants on each side of the membrane. A semi permeable membrane is a barrier that will pass some particles like clean drinking water, but not other particles like arsenic and lead.

Reverse osmosis uses a semi permeable membrane; however, by applying pressure across the membrane, it concentrates contaminants (like a strainer) on one side of the membrane, producing crystal clear water on the other. This is why RO systems produce both clean drinking water and waste water that is flushed from the system. This reverse osmosis system also utilizes carbon block filtration technology, and can therefore provide a higher quality drinking water than carbon filtration systems alone.

Your system is a six stage RO which is based upon separate treatment segments within the one complete water filtration system. These stages are as follows:

Stage 1 – Sediment filter, recommended change 6 months.

The first stage of your RO system is a five micron sediment filter that traps sediment and other particulate matter like dirt, silt and rust which affect the taste and appearance of your water.

Stage 2 & 3 – Carbon filter, recommended change 6 months.

The second and third stage contain a 5 micron carbon block filter. This helps ensure that chlorine, chloramines and other materials that cause bad taste and odor are greatly reduced.

Stage 4 & 5- Membranes, recommended change 2-5 years.

Stage four and five contain RO membranes. A semi permeable membrane will effectively take out TDS & Sodium and a wide range of contaminants such as Chromium, Arsenic, Copper, Lead as well as Cysts, such as Giardia and Cryptosporidium. Because the process of extracting this high quality drinking water takes time, your RO water treatment system is equipped with a storage tank.

Stage 6- Carbon in-line filter, recommended change 6 - 12 months.

The final stage is an in-line granular activated carbon (GAC) filter. This filter is used after the water storage tank and is used as a final polishing filter.

Note: Filter & Membrane life may vary based upon local water conditions and/or use patterns.

System Maintenance

Just because you can not taste it, does not mean that it is not there. Contaminants such as Lead, Chromium and Arsenic are undetectable to the taste. Additionally, over time if you do not replace the filter elements, other bad tastes and odors will be apparent in your drinking water.

With proper installation and maintenance, this system will provide you with high quality water for years to come. All of Premier's water enhancement products are rigorously tested by independent laboratories for safety and reliability.

If you have any questions or concerns, please contact our customer service department at 1-800-752-5582 (outside USA 480-675-7995) or refer to our on-line troubleshooting guide at www.premierH2o.com.

**** Before installation, please take a moment to fill out the warranty card on page 17.**

Table of Contents

Operational Parameters.....	4
Contents of Reverse Osmosis System.....	4
Installation & Startup	
Tools Recommended For Installation	4
Plumbing diagram and parts list.....	5
Drill a Hole for the Reverse Osmosis Faucet	6
How to use Quick Connect Fittings on Your RO System	6
Installation of Faucet	7
Connect Blue Tube to RO Faucet.....	7
Adapt-a-Valve Installation	8
Drain Saddle Installation.....	9
Drain Saddle Tube Connection.....	9
Green Tube Connection	9
Tank Ball Valve Installation	10
Blue Tube Connection - TANK.....	10
Blue Tube Connection - FAUCET	10
Reverse Osmosis Module Mounting.....	10
Start up Instructions.....	11
Maintenance & Troubleshooting	
Six Month System Maintenance	12
Annual Maintenance	13
Membrane Replacement	14
Check Air Pressure in the Tank	15
Procedure for Extended Non-Use (More than 2 months).....	15
Product Technical & Warranty Information	
Performance Data Sheet.....	16
Warranty Registration.....	17-18
Service Record.....	19
Limited Warranty	20

Operational Parameters

Do not use with water that is micro biologically unsafe or of unknown quality without adequate disinfection before or after the system. System is intended to be installed on the cold water line only.

Operating Temperatures:	Maximum 100°F (37.8°C)	Minimum 40°F (4.4°C)
Operating Pressure:	Maximum 100 psi (7.03 kg/cm ²)	Minimum 40 psi (2.80 kg/cm ²)
pH Parameters:	Maximum 11	Minimum 2
Iron:	Maximum 0.2 ppm	
TDS (Total Dissolved Solids)	< 1800 ppm	
Turbidity	< 5 NTU	

Hardness: Recommended hardness not to exceed 10 grains per gallon, or 170ppm. System will operate with hardness over 10 grains but the membrane life may be shortened. Addition of a water softener may lengthen the membrane life.

Water Pressure: The operating water pressure in your home should be tested over a 24 hour period to attain the maximum pressure. If the incoming water pressure is above 100 psi then a pressure regulator is required.

Copper Tubing: Reverse Osmosis water should not be run through copper tubing as the purity of the water will leach copper causing an objectional taste in water and pin holes may form in the tubing. Watts supplies speciality filters (part number 107008) that can be used if copper tubing follows the Reverse Osmosis unit. Be sure to follow any state or local regulations during installation.

Contents of Reverse Osmosis (RO) System

- 1 Tank
- 1 RO Module (complete with filters)
- 1 Manual
- 1 Parts Bag
- 1 Faucet Bag/Box

If any of the items are missing please contact Watts prior to installing.

INSTALLATION & STARTUP

Tools Recommended For Installation

- √ 3/4" Diamond Tipped Hole Saw bit for faucet opening (Counter Tops/Porcelain & Stainless Sinks)
- √ 1 1/4" Adjustable Wrench
- √ 1/2" Open End Wrench
- √ 5/8" Open End Wrench
- √ Electric Drill
- √ 1/8" diamond tip bit, pilot hole
- √ 1/4" drain, saddle hole
- √ Phillips bit for electric drill
- √ Needle Nose Pliers
- √ Adjustable Pliers
- √ Sharp Knife
- √ Phillips Screw Driver



Plumbing Diagram and Parts List

1	Faucet	116133
2	Polishing Filter	100014
3	Storage Tank	119019
4	Tank Ball Valve	134039
5	Elbow Fitting	125031
6	Housing - Blue	500015
7	Adapt-a-Valve	560080
8	Housing 1/4" Union	131021
9	Tee Fitting	125063
10	Drain Saddle 1/4"	164048
11	Shut Off Valve	134003
12	Fitting Adapter	125017
13	Membrane Housing	113101
14	Tee Fitting	125066

15	Compression Nut	125002
16	Green Tubing 1/4"	610109
17	Blue Tubing 1/4"	610113
18	White Tubing 1/4"	140009
19	System Bracket	137031
20	Tee Fitting	125053
21	In-line Check Valve	610019
22	Flow Restrictor	123001
23	Clip- Membrane to Filt.	164010
24	Sediment Filter	104017
25	Carbon Block Filter	101009
26	RO Membrane	110017
27	Clip - Membrane	164006
28	Filter Housing O-ring	113029

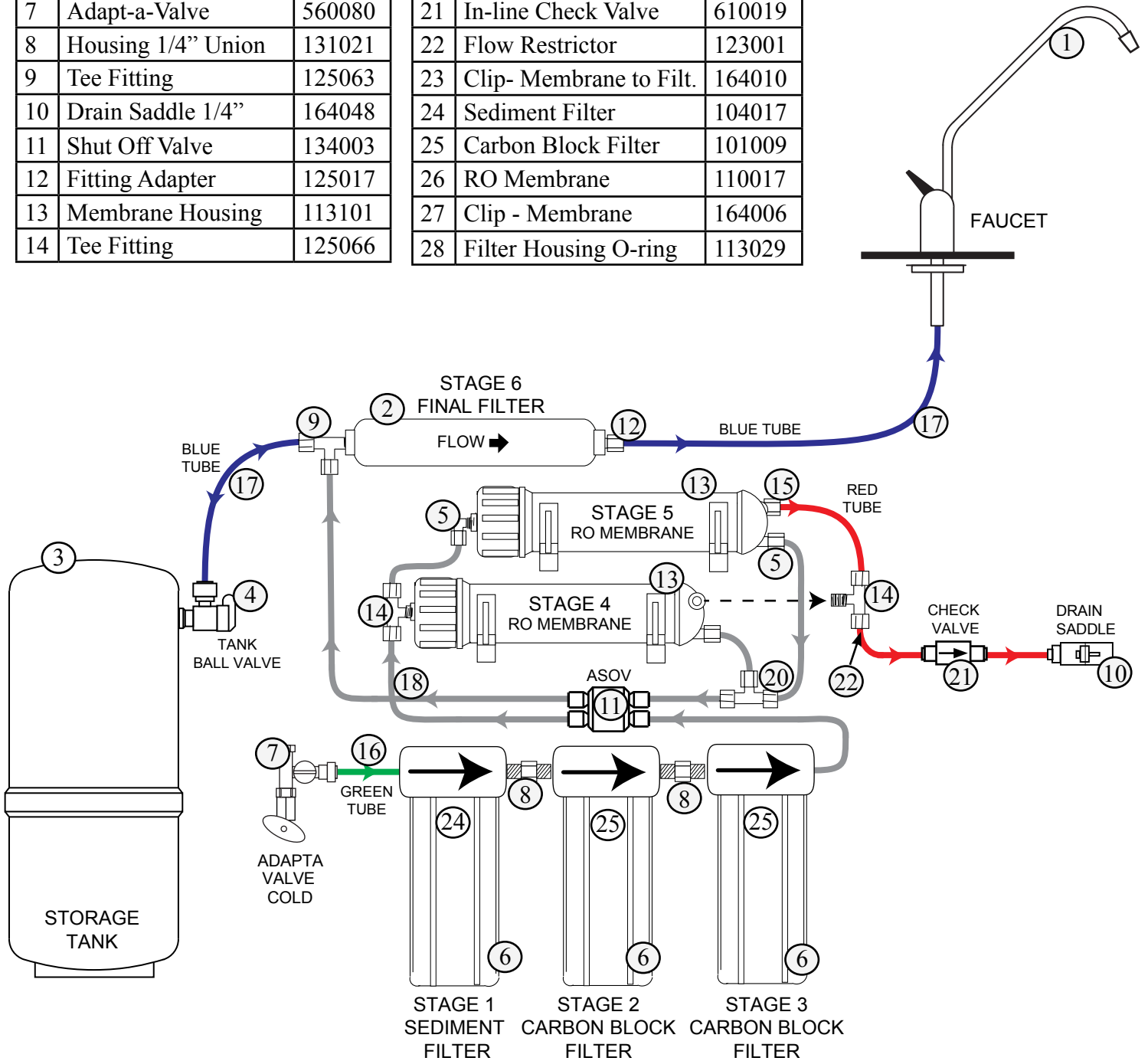

Drill a Hole for the Reverse Osmosis Faucet

Marble Counter-top

We recommend contacting a qualified contractor for drilling a hole in a marble counter-top.

Counter Top / Porcelain & Stainless Steel Sink

Note: Most sinks are pre drilled with 1 ¼" diameter hole that you can use for your RO faucet. (If you are already using it for a sprayer or soap dispenser, see step 1)

Porcelain sinks are extremely hard and can crack or chip easily. Use extreme caution when drilling. Watts accepts no responsibility for damage resulting from the installation of faucet. Diamond tip bit recommended.

- Step 1 Determine desired location for the RO faucet on your sink and place a piece of masking tape over where the hole is to be drilled. Mark the center of the hole on the tape.
- Step 2 Using a variable speed drill set on the slowest speed, drill a 1/8" pilot hole through both porcelain and metal casing of sink at the marked center of the desired location. Use lubricating oil or liquid soap to keep the drill bit cool (If drill bit gets hot it may cause the porcelain to crack or chip).
- Step 3 Using a 3/4" diamond tip hole saw, proceed to drill the large hole. Keep drill speed on the slowest speed and use lubricating oil or liquid soap to keep the hole saw cool during cutting.
- Step 4 After drilling, remove all sharp edges and make sure the surroundings of the sink are cooled before mounting the faucet.

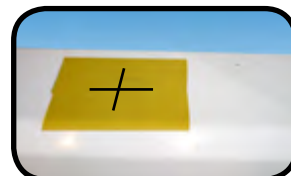

How to use the Quick Connect Fittings

To make a connection, the tube is simply pushed into the fitting. The unique locking system holds the tube firmly in place without deforming it or restricting flow. Use the steps below in reference to any quick connect tube connections.

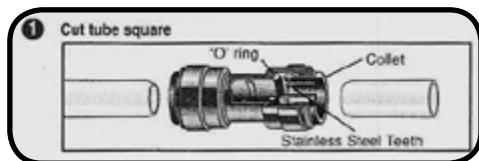

It is essential that the outside diameter be free of score marks and that burrs and sharp edges be removed before inserting into fitting.

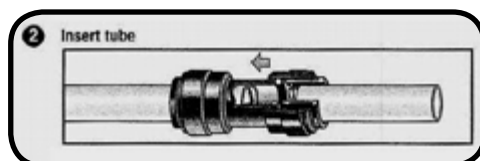

Fitting grips before it seals. Ensure tube is pushed into the tube stop.

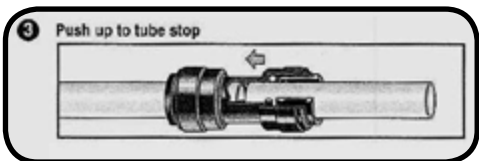

Push the tube into the fitting, to the tube stop. The collet (gripper) has stainless steel teeth which hold the tube firmly in position while the O-ring provides a permanent leak proof seal.

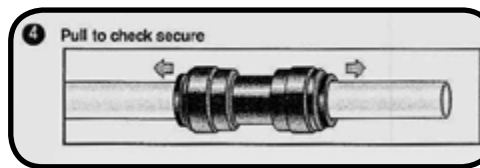

Pull on the tube to check that it is secure. It is a good practice to test the system prior to leaving site and /or before use.

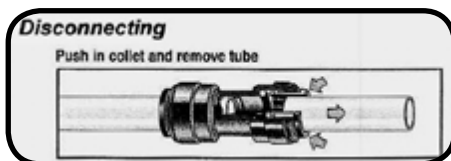

To disconnect, ensure the system is depressurized before removing the tube. Push in the collet squarely against face of fitting. With the collet held in this position, the tube can be removed. The fitting can then be reused.

Installation of Faucet

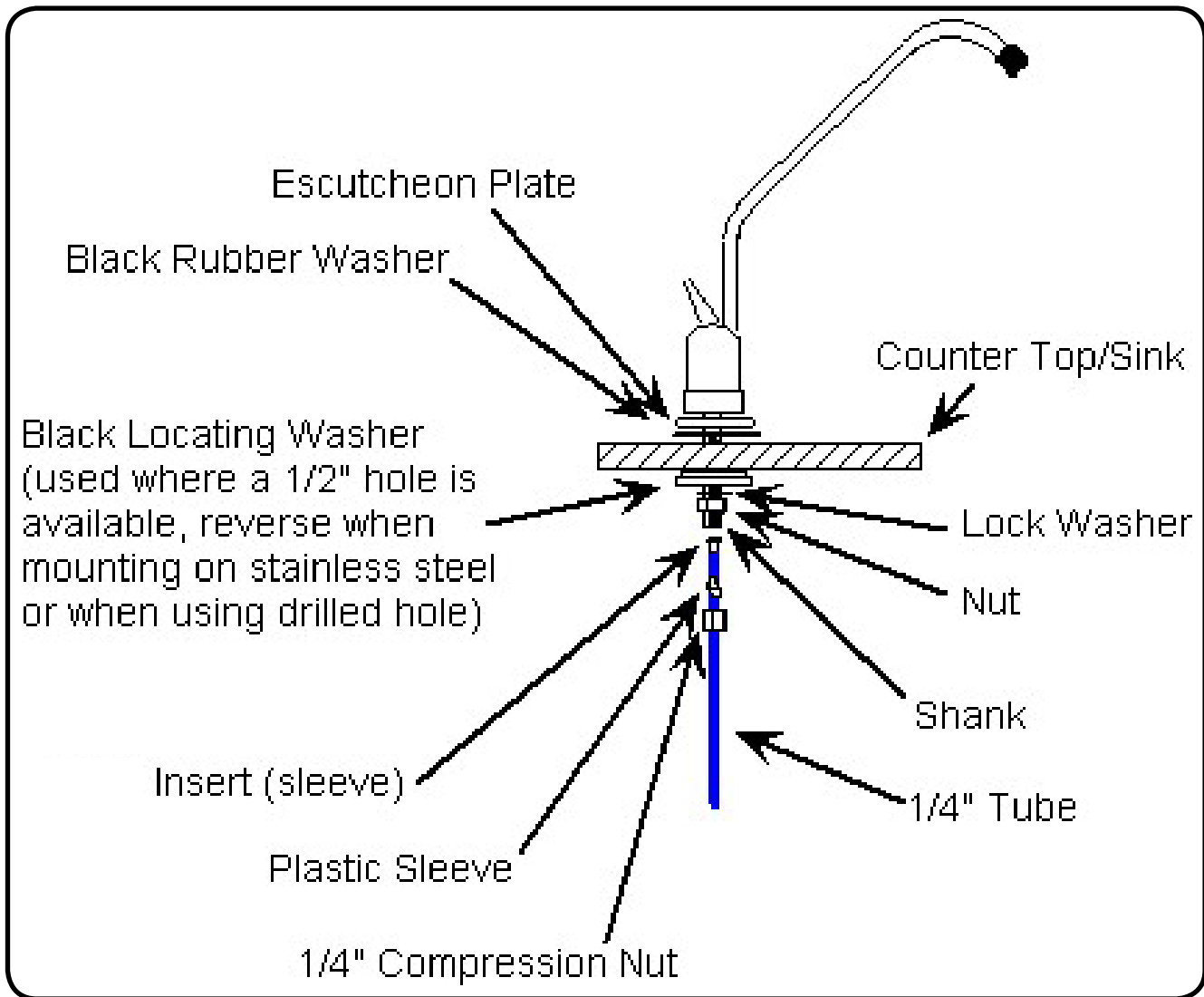

- Step 5 Place the escutcheon chrome plate and the black rubber washer on the faucet shank. (Parts found in faucet parts bag).
- Step 6 Insert the faucet shank through the hole in sink and let it rest on the sink top.
- Step 7 From the underside of the sink, slide on the locating washer, lock washer and brass nut onto the shank. Check orientation of faucet then tighten brass nut securely.

Connect Blue Tube to Faucet

- Step 8 Locate the blue 1/4" tube in the parts bag. Remove a brass nut, plastic sleeve and brass insert from the parts bag. To assemble, place the brass nut on the blue tube first, then the sleeve (small tapered end of sleeve must point to the end of tube) and then push the brass insert all the way into the end of the tube. (See Picture)
- Step 9 Insert the blue tube into the end of the faucet shank and use a wrench to tighten the brass nut securely.

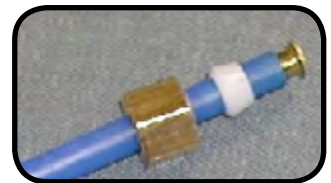

Adapt-a-Valve Installation

Caution:

Water supply line to the system must be from the cold water supply line only. Hot water will severely damage your system.

Verify contents prior to installation:

- (1) - Plastic Adapt-a-Valve with black collet
- (1) - Brass Adapter no washer
- (1) - Brass Adapter with black washer
- (1) - White rubber washer



3/8" Configuration
(With Brass Fittings)
* Insert White Washer



Hot Supply Cold Supply



1/2" Configuration
(Without Brass Fittings)

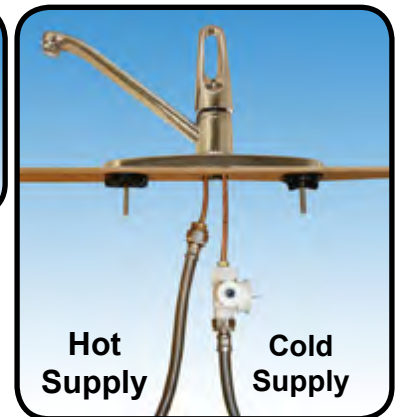

Hot Supply Cold Supply

WARNING: Do not use Teflon tape with the Adapt-a-Valve.

Step 10 Turn off the cold water supply to the faucet by turning the angle stop valve completely off. Open cold water sink faucet to relieve pressure.

Step 11 Choosing the configuration that fits your plumbing, attach the adapt-a-valve as illustrated in the four photos above.

TIPS: Make sure that the black collet is installed in to the 1/4" opening on the Adapt-a-valve. Don't forget to install the white compression washer with the 3/8" configuration. Brass adapter (A) does not need to be tightened with a wrench, only finger tight.

Drain Saddle Installation - Fits standard 1 1/4" – 1 1/2" drain pipes

Caution: *If you have a garbage disposal, do not install the drain saddle near it. Installation of the drain saddle must be either above the garbage disposal, or if a second sink drain is available, install it above the cross bar on the second drain. Installation of the drain saddle near a garbage disposal may cause the drain line to plug.*

Follow all local plumbing codes for your installation.

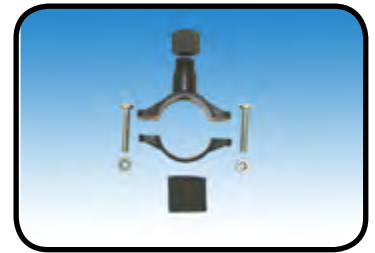

Step 12 Locate the correct drain saddle kit in the parts bag.

Step 13 The small square black foam gasket with a circle cut out of the middle must be applied to the inside of the drain saddle. Remove sticky tape backing and stick to the drain saddle. (See Picture to Right)

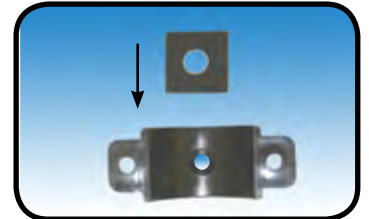

Step 14 The drain saddle must be installed at least 1 1/2" above the nut of the P-Trap elbow or cross bar from the garbage disposal to insure proper drainage. Using the 1/4" drill bit, drill into the drain pipe at best available location as specified above, for drain saddle installation. **Take extreme caution to only drill through one side of the drain pipe.**



Step 15 Assemble the drain saddle around the drain pipe and **align drain saddle fitting opening with the hole drilled in the previous step** - you may use a small screwdriver to feed through the drain saddle into the drain pipe to aid with the alignment. Using a Phillips screw driver tighten the drain saddle bolts evenly and securely on both sides.

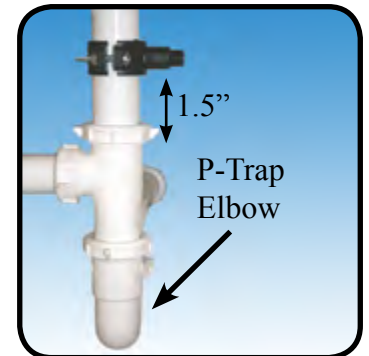

Caution: *Do not over tighten the screws. It may crack the drain saddle.*

Drain Saddle Tube Connection

Step 16 In the parts bag locate the 1/4" red tube with an attached one way check-valve. Connect the open end of the quick connect check valve to the short red tube attached to the Tee fitting on the lower RO membrane housing by pushing it all the way to the tube stop. Connect the other open end of the red tube to the quick connect fitting on the drain saddle by pushing the tube all the way to the tube stop.



Green Tube Connection

Step 17 In the parts bag locate the 1/4" Green tubing. Connect the tube to the RO system (left housing) by inserting it into the open 1/4" compression elbow fitting on the housing lid. Make sure the tube is pushed in all the way. Use a 5/8" wrench to tighten the white plastic nut securely.

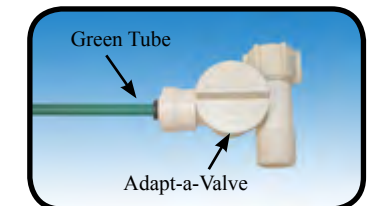

Step 18 Insert the other open end of the green 1/4" tube into the open 1/4" quick connect fitting on the plastic adapt-a-valve making sure the tube is pushed in all the way to the tube stop.

Tank Ball Valve Installation

Step 19 Thread the plastic ball valve onto the tank fitting. Do not apply Teflon tape to fitting. **Do not over tighten or the valve could crack.**

Blue Tube Connection - TANK

Step 20 Locate the 1/4" blue tube in the parts bag. Insert one open end FIRMLY into the open **TEE** fitting attached to the LEFT side of the final stage filter. Use a 5/8" wrench to tighten the white plastic nut securely.



Step 21 Position tank in desired location. Insert the open end of the blue 1/4" tube from the RO System FIRMLY into the tank ball valve. Use a 5/8" wrench to tighten the white plastic nut securely.

Note: Set the ball valve knob in-line with the yellow tube, this is the "open" position.

Blue Tube Connection - FAUCET

Step 22 Locate the 1/4" blue tube attached to the RO faucet. Insert the tube FIRMLY into the 1/4" open fitting on the RIGHT side of the final stage filter. Use a 5/8" wrench to tighten the white plastic nut securely.



Reverse Osmosis Module Mounting

Step 23 Determine best location for the RO module to be mounted to allow for future system maintenance. Using the mounting holes on the bracket, mark the location for the mounting screws on the cabinet wall under the sink. In the parts bag, locate the two self tapping screws. Using an electric drill with a Phillips bit, screw them into the cabinet at the marked location. Hang the module on the screws using the mounting holes in the bracket

Caution: *This RO system is very heavy once filled with water.*
Use wall/cabinet studs when mounting to prevent damage to mounting surface.

Congratulations!

You have completed the installation of your new Reverse Osmosis system.

Please Follow the Startup Instructions.

Start up Instructions

Step 1 Turn on the incoming cold water at the angle stop valve and the Adapt-a-Valve. Check the system for leaks and tighten any fittings as necessary. (Check frequently over the next 24 hours to ensure no leaks are present).

Note: *If you have connected your RO system to a refrigerator / ice maker, make sure the ice maker is off (do not allow water to flow to the ice maker) until flushing (Step 4) is complete and the tank has been allowed to fill completely. Connection from the RO to the ice maker system should have an in-line valve installed before the ice maker so it can easily be closed to prevent water flowing to the ice maker during start up and periodic maintenance. Your storage tank must be allowed to fill up fully in order for the ice maker system to work properly.*

Step 2 Open the RO faucet and leave it open until water begins to trickle out (this may take a few minutes and the water will come out slowly).

Step 3 Close the RO faucet allowing the storage tank to fill with water.

Note: *During the fill period you may hear water trickling which is a normal occurrence.*

Step 4 After the storage tank has filled (the water trickling has stopped), open the RO Faucet to flush the tank completely. You will know that the tank is empty when the flow rate from the RO faucet is down to a trickle. Repeat this step two more times. The fourth tank can be used for drinking.

Note: *Flushing of the tank 3 times is only necessary during the initial startup and after replacing the membranes.*

System Maintenance

Six Month Maintenance

Items needed:

- √ **Stage 1 - Sediment Filter (part #: 104017)**
- √ **Stage 2 & 3 - Carbon Block Filter (part #: 101009)**

- Step 1 Turn off the incoming water supply to the RO at the feed water valve. (Follow the green tube away from the RO system to find the valve.)
- Step 2 Close ball valve on the storage tank and open the RO Faucet to depressurize.
- Step 3 Let system sit for one minute after the tank is empty to let the system depressurize before attempting to remove filter housings.
- Step 4 For more leverage you may leave the RO module attached to wall of cabinet. If you are unable to access the module while it is mounted, remove it prior to changing filters. Remove stage one housing (left side of module) by turning it clockwise (left), empty water, then discard filter.
- Step 5 Remove stage two and three housing by turning them clockwise (left), empty water, then discard filters.
- Step 6 Clean the filter housings with a mild soap solution and rinse with water. Check O-rings and lubricate with water soluble lubricant. Vegetable or olive oil lubricants may be used. Petroleum based lubricants (such as Vaseline®) must not be used.
- Caution:** *Before re-installing the filter housings back on to the system, check O-rings to make sure they are still in place.*
- Step 7 Insert the new sediment filter (cloth like appearance) into the stage 1 housing and re-install housing.
- Step 8 Insert the new Carbon Block filter (White End Caps) into the stage 2 and 3 housing and re-install housings.
- Step 9 Follow Start-up procedure on page 11.

System Maintenance Continued...

Annual Maintenance

Items needed:

- √ **Stage 1 - Sediment Filter (part #: 104017)**
- √ **Stage 2 & 3 - Carbon Block Filter (part #: 101009)**
- √ **Stage 6 - Final In-line Filter (part #: 100014)**

Note: *Sanitizing of unit is recommended.*

Step 1 Perform steps 1 through 5 in the Six Month System Maintenance (Page 12).

Note: *If not sanitizing the system skip to step 8.*

Step 2 Remove the RO membranes from their housings and rest them in a clean sanitary place. (Refer to "Membrane Replacement" section on page 14 for directions on removing the membranes). Replace cap onto empty membrane housings and re-connect white tubing.

Step 3 Leaving the filters out, replace stage 2 and 3 empty filter housings (hand tight) onto unit. Measure & pour either 1/2 cup of hydrogen peroxide or common household bleach into the 1st filter housing (Stage 1) and hand tighten onto unit.

Step 4 With the RO faucet in the closed position turn on the incoming water supply to the system. Wait 1 minute for the unit to pressurize. Turn on the RO faucet and let the water run for 30 seconds. Turn off the RO faucet and let the unit rest for 2 minutes. Finally, open the RO faucet and let the water run for 5 more minutes.

Step 5 Turn off the incoming water supply to the system. Keep the RO faucet open until the storage tank is completely drained.

Step 6 Open the membrane housings and re-install the RO membranes while making sure not to kink the O-rings. (Refer to "Membrane Replacement" section on page 14 for directions on installing the membrane). Tighten the caps back on the housings and reconnect white tubing.

Step 7 Remove filter housings Stage 1, 2 & 3 and empty of water.

Caution: *Before re-installing the filter bowls back on to the system, check O-rings to make sure they are still in place and lubricate with water soluble lubricant.*

Step 8 Insert the new sediment filter (cloth like appearance) into the 1st filter housing which is the one on the water inlet side (green tubing from the adapt-a-valve) of the RO system and re-install housing.

Step 9 Insert the new Carbon Block filter (White End Caps) into the 2nd and 3rd housing and re-install housings.

Step 10 The final in-line filter clipped on to the top of the reverse osmosis membrane housing. Remove it from the holding clips and remove the compression fittings on both ends of the filter. Install fittings on to new filter and re-connect. (Discard used final filter after sanitizing)

Note: *The flow arrow on the final filter must be pointing towards the RO faucet / away from the RO storage tank.*

Tip: *This is a good time to check the air pressure in your storage tank. For instructions please see page 15.*

Step 11 Follow Start-up procedure on page 11.

This reverse osmosis system contains a replaceable component (the RO membrane) which is critical to the efficiency of the system. Replacement of this reverse osmosis membrane should be with one of identical specifications as defined by Watts to assure the same efficiency and contaminant reduction performance.

Membrane Replacement

Membranes have a life expectancy between 2 and 5 years, depending on the incoming water conditions and the amount the RO system is used. This reverse osmosis membrane is critical for effective reduction of total dissolved solids (TDS). The product water should be tested periodically to verify that the system is performing satisfactorily. Normally, a membrane would be replaced during a semiannual or annual filter change. However, if at any time you notice a reduction in water production or an unpleasant taste in the reverse osmosis water, it could be time to replace the membrane. Watts recommends replacing the membrane when TDS reduction falls below 75%.

Note: *A water sample may be sent to Watts for a free diagnosis of your membrane performance. To send a water sample, use two (2) clean containers and fill ½ cup of tap water in one container and ½ cup of reverse osmosis water in 2nd container. Clearly label each sample. Send the samples to the address listed on the cover of this manual attention “Water Samples”. Watts will test the water and mail or call you with the results.*

Step 1 Turn off the incoming water supply to the RO.

Step 2 Open the RO Faucet and allow water to drain from the tank until it is completely empty.

Removing the membrane:

Step 3 Use a 5/8” wrench to remove the White Tube on the left side of the horizontal membrane housing.

Step 4 Remove the cap from the membrane housing by turning it counter clockwise to loosen.

Step 5 Remove membrane housing from the holding clips. Using a pair of pliers, grip the PVC tube of the RO membrane and pull firmly on the membrane to remove from the housing and discard.

Step 4 Repeat above steps to remove second membrane from the housing.

Installing the membrane:

Step 6 Lubricate the O-rings on the new membrane with a water soluble lubricant such as vegetable or olive oil. Insert the end with the two black O-rings first into the housing.

Step 7 Once membrane has been inserted into the housing you must take your thumbs and give a firm push to properly seat the membrane. Replace membrane housing cap and tighten.

Step 8 After replacing membrane housing into clips, re-attach the white tube to the fitting on cap and tighten using 5/8” wrench.

Step 9 Repeat above steps to install second membrane into the housing.

Step 10 Follow the Start Up Instructions on page 11.

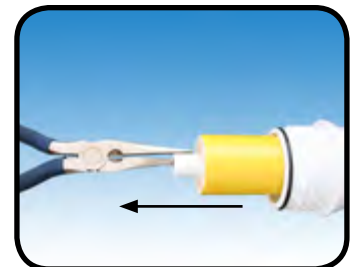

Check Air Pressure in the Tank

Important: *Check air pressure only when tank is empty of water!*

Check air pressure in the storage tank when you notice a decrease in available water from the RO system. Air can be added with a bicycle pump using the schrader valve that is located on the lower side of the tank behind a blue plastic cap.

- Step 1 Turn off the cold water supply to the RO and unplug transformer.
- Step 2 Open the RO Faucet and allow water to drain from the tank until it is completely empty.

Tip: *When water from the RO faucet slows to a trickle, with the faucet still in the open position, you may add air to the tank to purge any left over water, this will ensure that the tank is completely empty.*



- Step 3 Once all water in the tank is purged, check air pressure using an air pressure gauge, it should read between 5 - 7 PSI. (Digital air pressure gauge is recommended) Pressurize tank using a bicycle tire pump if low. Follow start-up procedure on page 11.

Procedure for Extended Non-Use (More than 2 months)

Turn off the cold water supply to your RO system, unplug power transformer from electrical outlet and open the RO faucet to drain the storage tank. Once the storage tank is empty, remove the Reverse Osmosis Membrane, place it into a sealed plastic bag and store in your refrigerator (DO NOT FREEZE).

To Restart System:

- Step 1 Reinstall reverse osmosis membrane.
 - Step 2 Turn on the cold water supply to your RO system. Plug in the transformer, (Check frequently over the next 24 hours to ensure no leaks are present).
- Note:** *If you have connected your RO system to a refrigerator / ice maker, make sure the ice maker is off (do not allow water to flow to the ice maker) until the tank has been allowed to completely fill.*
- Step 3 Open the RO faucet and leave it open until water begins to trickle out (it will come out slowly).
 - Step 4 Close the RO faucet allowing the storage tank to fill with water. It may take 3 hours to fill the tank completely depending on the production capability of the membrane, local water temperature and water pressure.
 - Step 5 After the Tank has filled, open the RO Faucet to flush the tank completely. You will know that the tank is empty when the flow rate from the RO faucet is down to a trickle. The second tank can be used for drinking.

California Proposition 65 Warning

WARNING: this product contains chemicals known to the State of California to cause cancer and birth defects or other reproductive harm. (Installer: California law requires that this warning be given to the consumer). For more information: www.wattsind.com/prop65.

TECHNICAL & WARRANTY INFORMATION

Performance Data Sheet

WP-ST6DM

Premier Inc.
8716 W Ludlow Drive Suite #1
Peoria, AZ 85381
(480) 675-7995 wpmail@wattsind.com

GENERAL USE CONDITIONS:

1. System to be used with municipal or well water sources treated and tested on regular basis to insure bacteriological safe quality. Do not use with water that is microbiologically unsafe or unknown quality without adequate disinfection before and after the system.
2. Operating Temperature: Maximum: 100°F (40.5°C) Minimum: 40° (4.4°)
3. Operating Water Pressure: Maximum: 100 psi (7.03kg/cm2) Minimum: 40 psi (2.8kg/cm2)
4. pH 2 to 11
5. Hardness of more than 10 grains per gallon (170 ppm) may reduce TFM membrane life expectancy.
6. Recommend TDS (Total Dissolved Solids) not to exceed 1800 ppm.

RECOMMENDED REPLACEMENT PARTS AND CHANGE INTERVALS:

Depending on incoming feed water conditions replacement time frame may vary.

<u>Change Time</u>	<u>Description</u>
6 months:	Sediment Pre-filter (104017) Carbon Pre-filter (101009)
12 months	Final Carbon filter (100014)
2 to 5 years	R.O. Membrane (110017)

The membranes have been tested according to NSF/ANSI 58 for reduction of the substances below. The concentration of the indicated substances in water entering the system was reduced to a concentration less than or equal to the permissible limit for water leaving the system as specified in NSF/ANSI 58. The membranes have been tested for the treatment of water containing pentavalent arsenic (also known as As (V), As (+5), or arsenate) at concentrations of 0.30 mg/L or less. This system reduces pentavalent arsenic, but may not remove other forms of arsenic. This system is to be used on water supplies containing a detectable free chlorine residual at the system inlet or on water supplies that have been demonstrated to contain only pentavalent arsenic. Treatment with chloramine (combined chlorine) is not sufficient to ensure complete conversion of trivalent arsenic to pentavalent arsenic. Please see the Arsenic Facts section of the installation manual for further information.

	Avg. In. (mg/L)	Avg. Eff. (mg/L)	% Reduction	pH	Pressure	Max Eff. mg/L	Inf. challenge concentration mg/L	Max Allowable concentration mg/L
Arsenic (Pentavalent)	334.62 ug/L	5.039 ug/L	98.4%		50psi	19 ug/L	0.30±10%	0.010 mg/L
Barium Reduction	10.2	0.13	98.7%	7.24	50psi	0.27	10.0±10%	2.0
Cadmium Reduction	0.031	0.0001	99.7%	7.49	50psi	0.0009	0.03±10%	0005
Chromium (Hexavalent)	0.30	0.006	98.0%	7.24	50psi	0.013	0.03±10%	0.1
Chromium (Trivalent)	0.30	0.003	99.0%	7.24	50psi	0.008	0.03±10%	0.1
Copper Reduction	3.0	0.04	98.7%	7.64	50psi	0.06	3.0±10%	1.3
Cysts	222,077#/ml	10 #/ml	99.99%		50psi	58	minimum 50,000/mL	N/A
Fluoride Reduction	8.0	0.33	95.9%	7.49	50psi	0.47	8.0±10%	1.5
Lead Reduction	0.15	0.004	97.3%	7.49	50psi	0.008	0.15±10%	0.0107
Radium 226/228	25pCi/L	5pCi/L	80.0%	7.24	50psi	5pCi/L	25pCiL±10%	5pCiL
Selenium	0.10	<0.001	99.0%		50psi	<0.001	0.10±10%	0.05
TDS	765	24	96%	7.84	50psi	39.0	750±40mg/L	187
Turbidity	81 NTU	0.15 NTU	99.8%		50psi	0.28 NTU	11±1 NTU	0.5 NTU

Testing performed under standard laboratory conditions, actual performance may vary. Refer to owners manual for further maintenance requirements and warranty information.

Phone: (480) 675-7995

Fax: (623) 866-5666

Email: wpmail@watts.com

WARRANTY REGISTRATION

Please Fill out and keep for your Records

First Name: _____ Last Name: _____

Address: _____ City: _____

State/Prov: _____ Zip/Postal Code: _____

Country: USA CANADA MEXICO OTHER _____

Phone # _____ - _____ - _____ Email Address: _____

Date of Purchase: _____ Date of Install: _____

Installed By: SELF Plumbing Professional Where Purchased: _____

Model Number: _____ Serial Number: _____ - _____
 xxxxxx - xxxxxxx

Iowa Department of Public Health - Sales in Iowa require this to be completed, signed and returned. These signatures will be retained on file for two years.



Insert into envelope and return to Premier

Premier
8716 W Ludlow Drive Suite #1
Peoria, AZ 85381

Service Record

Date of Purchase: _____ Date of Install: _____ Installed by: _____

Date	1st stage Sediment (6 months)	2 & 3 stage Carbon (6 months)	Final Filter Carbon (1 year)	TFM Membranes (2-5 years)

NOTES:

Limited Warranty

What your Warranty Covers:

If any part of your WATTS Reverse Osmosis System is defective in workmanship (excluding replaceable filters and membranes), return unit after obtaining a return authorization (see below), less tank, within 1 year of original retail purchase, WATTS will repair or, at WATTS'S option, replace the system at no charge.

How to obtain Warranty Service:

For warranty service, call 1-800-752-5582 for documentation and a return authorization number. Once the return authorization number has been created, ship your Reverse Osmosis unit (less tank) to our factory, freight and insurance prepaid, with proof of date of original purchase. Include a note stating the problem experienced and include your name, address and your return authorization number. No returns will be accepted with out the proper return authorization number. WATTS will repair it, or replace it, and ship it back to you prepaid.

What this warranty does not cover:

This warranty does not cover defects resulting from improper installation, (contrary to WATTS'S printed instructions), from abuse, misuse, misapplication, improper maintenance, neglect, alteration, accidents, casualties, fire, flood, freezing, environmental factors, water pressure spikes or other such acts of God.

This warranty will be void if defects occur due to failure to observe the following conditions:

1. The Reverse Osmosis System must be hooked up to a potable municipal or well cold water supply.
2. The hardness of the water should not exceed 10 grains per gallon, or 170 ppm.
3. Maximum incoming iron must be less than 0.2 ppm.
4. The pH of the water must not be lower than 2 or higher than 11.
5. The incoming water pressure must be between 40 and 85 pounds per square inch.
6. Incoming water to the RO cannot exceed 100 degrees F (40 degrees C.)
7. Incoming TDS/Total Dissolved Solids not to exceed 1800 ppm.
8. Do not use with water that is micro biologically unsafe or of unknown quality without adequate disinfection before or after the system.

This warranty does not cover any equipment that is relocated from the site of its original installation.

This warranty does not cover any charges incurred due to professional installation.

This warranty does not cover any equipment that is installed or used outside the United States of America and Canada.

LIMITATIONS AND EXCLUSIONS:

WATTS WILL NOT BE RESPONSIBLE FOR ANY IMPLIED WARRANTIES, INCLUDING THOSE OF MERCHANTABILITY AND FITNESS FOR A PARTICULAR PURPOSE. Watts WILL NOT BE RESPONSIBLE FOR ANY INCIDENTAL OR CONSEQUENTIAL DAMAGES, INCLUDING TRAVEL EXPENSE, TELEPHONE CHARGES, LOSS OF REVENUE, LOSS OF TIME, INCONVENIENCE, LOSS OF USE OF THE EQUIPMENT, AND DAMAGE CAUSED BY THIS EQUIPMENT AND ITS FAILURE TO FUNCTION PROPERLY. THIS WARRANTY SETS FORTH ALL OF WATTS'S RESPONSIBILITIES REGARDING THIS EQUIPMENT.

OTHER CONDITIONS:

If WATTS chooses to replace the equipment, WATTS may replace it with reconditioned equipment. Parts used in repairing or replacing the equipment will be warranted for 90 days from the date the equipment is returned to you or for the remainder of the original warranty period, whichever is longer. This warranty is not assignable or transferable.

YOUR RIGHTS UNDER STATE LAW:

Some states do not allow limitations on how long an implied warranty lasts, and some states do not allow the exclusion or limitation of incidental or consequential damages, so the above limitations or exclusions may not apply. This warranty gives you specific legal rights, and you may have other legal rights which vary from state to state.